

# **PRO** Glass

**AUTO GLASS TOOLS & ACCESSORIES**

**EDITION 2025/2026**

# Cut-Out Technology



# Preparation



# Installation



# Specialty Tools



# Repair



# Protection & Care



<b>Cord &amp; Wire Cut-Out Technology</b>	<b>5</b>	<b>1</b>
<b>Pull Knife Cut-Out Technology</b>	<b>37</b>	<b>2</b>
<b>Power Tools (electric &amp; pneumatic)</b>	<b>49</b>	<b>3</b>
<b>Dismantling &amp; Installation Tools</b>	<b>77</b>	<b>4</b>
<b>Scrapers &amp; Miscellaneous Cutting Tools</b>	<b>105</b>	<b>5</b>
<b>Sensor Technology</b>	<b>123</b>	<b>6</b>
<b>Auto Glass Installation</b>	<b>141</b>	<b>7</b>
<b>Calibration &amp; Diagnostics</b>	<b>167</b>	<b>8</b>
<b>Adhesive, Tapes &amp; Rubber Profiles</b>	<b>187</b>	<b>9</b>
<b>Other Hand Tools</b>	<b>211</b>	<b>10</b>
<b>Toolkits &amp; Storage Systems</b>	<b>227</b>	<b>11</b>
<b>Transportation &amp; Storage of Glass</b>	<b>245</b>	<b>12</b>
<b>Windscreen Repair &amp; Scratch Removal</b>	<b>257</b>	<b>13</b>
<b>Headlight Restoration</b>	<b>293</b>	<b>14</b>
<b>Vehicle Protection &amp; Personal Protective Equipment</b>	<b>299</b>	<b>15</b>
<b>Cleaning, Maintaining &amp; Coating</b>	<b>311</b>	<b>16</b>

# FOLLOW US ON OUR SOCIAL MEDIA CHANNELS

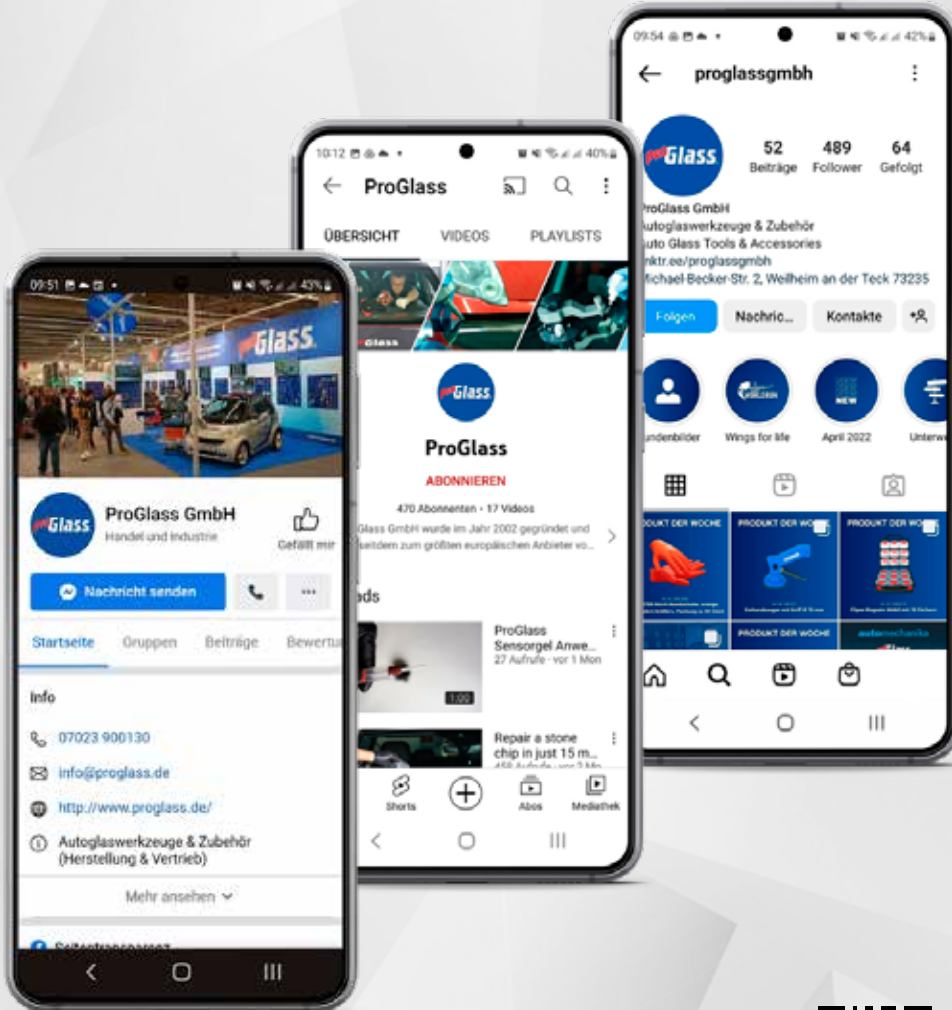

quicklink to  
all channels



## IMPRINT

### Editor

ProGlass GmbH  
Michael-Becker-Strasse 2  
73235 Weilheim  
Germany

Phone: +49 (0) 7023 / 90013-0  
Fax: +49 (0) 7023 / 90013-23  
E-Mail: [info@proglass.de](mailto:info@proglass.de)  
Internet: [www.proglass.de](http://www.proglass.de)

VAT Reg. No.: DE 813 343 270

Managing Director: Oliver Siegler

Registered at local court  
Stuttgart, HRB 231787

### Copyright Note

This catalogue is copyrighted. Reproduction of any part in any way is prohibited without the exclusive written consent of ProGlass GmbH.

### Trademarks

The name ProGlass and the ProGlass logo is a trademark by Oliver Siegler in favour of ProGlass GmbH.

Other product or company names in this catalogue are trademarks of the relative companies.

Date of Issue: August 2024  
Errors and technical changes excepted!



When it was launched in 2012, the SPIDER from WRD Glass Tools revolutionised the glass removal market! The patented separating device was the first of its kind to enable the **completely damage-free separation of bonded vehicle windows**. A specially developed, extremely strong plastic separating cord is used to cut through the adhesive bead. This not only protects the bodywork and add-on parts, but also enables very fast work.



Due to the enormous increase in the tensile strength of the cord in recent years, the device itself has also had to become more and more stable. The current versions **SPIDER 3, SPIDER 4 and ORANGE BAT, ORANGE BAT QC** therefore contain several detail improvements which either serve to increase the stability or to optimise the working method. Detailed information can be found in the product brochure and our website.

**Schematic working method for a bonded windscreen removal in only four steps:**

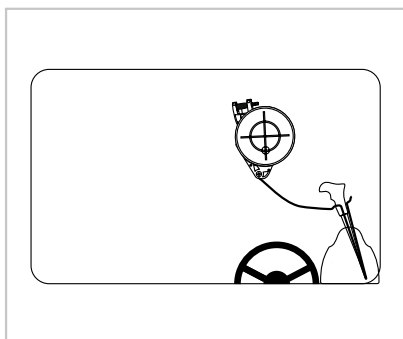

**PREPARATIONS:**

Pierce the line from inside to outside with the threading tool,...

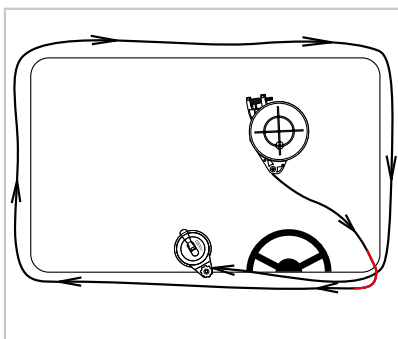

...guide it around the glasses edge and secure it with the anchor suction cup.

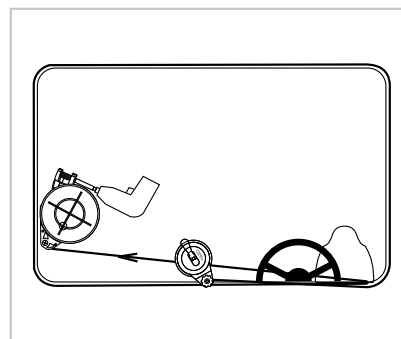

**STEP 1:**

Cut the adhesive bead from the starting point to the bottom right corner.

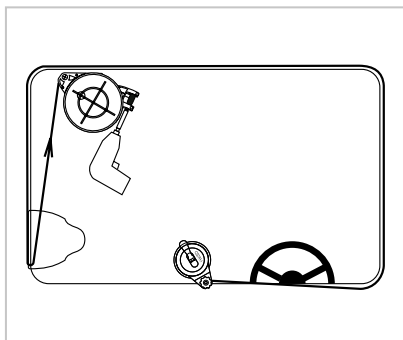

**STEP 2:**

Continue cutting the right A-pillar upwards until you reach the top right corner.

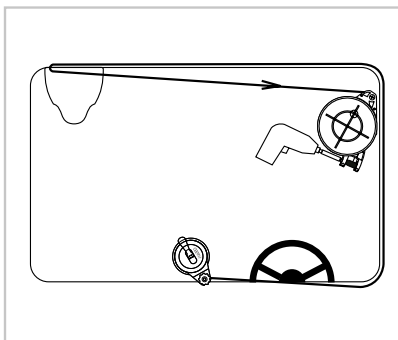

**STEP 3:**

Continue cutting across the roofside to the top left corner.

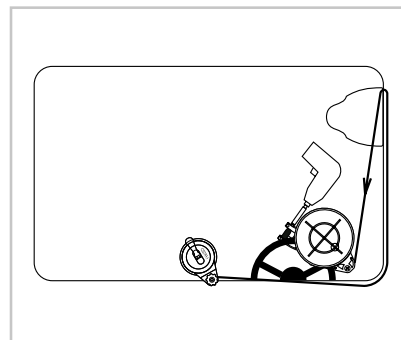

**STEP 4:**

Cut the left A-pillar downwards to the starting point.



■ **WSP-003K**

**Removal Device SPIDER 3  
complete kit in plastic case**

Kit contains:

- 1 SPIDER cutting tool
- 1 cutting line threader (item no. DST-757-WSP)
- 1 dash protector (item no. DBP-1824-WSP)
- 1 bit long (item no. WSR-003K-BIT-L)
- 1 bit short (item no. WSR-003K-BIT-K)
- 4 holder pins (item no. WRD-LP)
- 1 cutting line install tool (item no. WRD-ISC-O)
- 1 Spider cutting line, spool at 96 m (item no. P8)
- 1 anchor suction cup (item no. AS-115-K)
- 1 mini hook (item no. MH-140-WSP)
- 1 line & wire dispenser (item no. WRD-LD)
- 1 instruction manual
- 1 foam lined plastic case

Additionally needed accessories:

High-torque variable speed cordless drill, e.g.  
Cordless Drill/Driver Milwaukee 12 V (item no. ASM-M12) or  
Cordless Drill/Driver Milwaukee 18 V (item no. ASM-M18)



European Patent  
No. EP 2 540 463  
German Utility Patent  
No. 20 2012 009 378.9

**Further patents pending**

*quicklink to the  
product video*



■ WSP-004K

**Removal Device SPIDER 4  
complete kit in plastic case**

Kit contains:

- 1 SPIDER cutting tool
- 1 cutting line threader (item no. DST-757-WSP)
- 1 dash protector (item no. DBP-1824-WSP)
- 1 bit long (item no. WSR-003K-BIT-L)
- 1 bit short (item no. WSR-003K-BIT-K)
- 4 holder pins (item no. WRD-LP)
- 1 cutting line install tool with cutter (item no. WRD-ISC-O)
- 1 Spider cutting line, spool at 96 m (item no. P8)
- 1 anchor suction cup (item no. AS-115-K)
- 1 mini hook (item no. MH-140-WSP)
- 1 line & wire dispenser (item no. WRD-LD)
- 1 instruction manual
- 1 foam lined plastic case

Additionally needed accessories:

High-torque variable speed cordless drill, e.g.

Cordless Drill/Driver Milwaukee 12 V (item no. ASM-M12) or

Cordless Drill/Driver Milwaukee 18 V (item no. ASM-M18)



European Patent  
No. EP 2 540 463  
German Utility Patent  
No. 20 2012 009 378.9

**Further patents pending**

*quicklink to the  
product video*





■ **WRBIS-300K Fibre Line Removal Device Bison**  
**Complete kit in plastic case**



The new Bison from WRD Glass Tools is the ideal powerful solution for quick and damage-free removal of all bonded vehicle windows.

The particularly robust tool with a 210 mm curved suction pad has been specially designed to cut through the wider adhesive beads on trucks and buses and can be used both mechanically and manually!

The tool can be operated manually with the hand crank supplied and mechanically with a cordless screwdriver. The specially developed, extremely strong P10 plastic cutting cord is used to cut through the adhesive bead. This not only protects the bodywork and add-on parts, but also enables very fast work.

Kit contains:

- 1 BISON cutting tool
- 1 hand crank (item no. WRD-BNHC)
- 1 cutting line threader (item no. DST-757-WSP)
- 1 dash protector (item no. DBP-4024-WSP)
- 1 bit 5/16" (item no. WRD-BNB)
- 1 bit adapter 1/4" to 5/16" (Art.-Nr. WRD-BNBA)
- 1 U-bit (item no. WRD-BNUB)
- 1 cutting line install tool with cutter (item no. WRD-ISC-O)
- 1 Spider cutting line, spool at 80 m (item no. P10)
- 1 line & wire dispenser (item no. WRD-LD)
- 1 mini hook (item no. MH-140-WSP)
- 4 holder pins (item no. WRD-LP)
- 1 instruction manual
- 1 foam lined plastic case

Recommended accessories: High-torque variable speed cordless drill, e.g. Milwaukee Cordless Drill/Driver 18.0 V Li-Ion / 2.0 Ah (ASM-M18)



*quicklink to the  
product video*



The Orange Bat from WRD Glass Tools is the ideal solution for quickly and safely removing all bonded vehicle windows – both manually and with a drill!

The tool can be operated either manually with the supplied hand crank or with a cordless screwdriver.

The specially developed, extremely durable synthetic cutting cord XN-96 is used to cut through the adhesive bead. This not only protects the body and the attached parts, but also enables very fast working.



**Schematic method of working to cut out a windscreen in just four steps:**

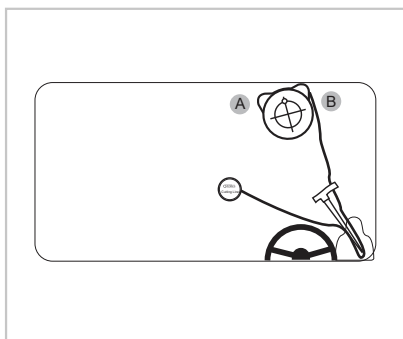

**PREPARATIONS:**

Insert the cord outwards through the adhesive bead,...

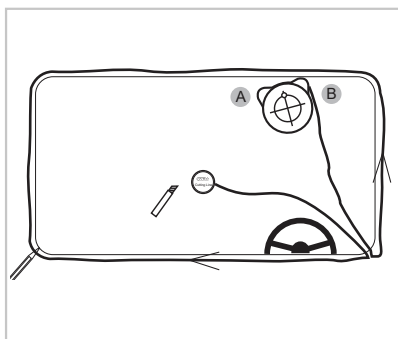

...around the edge of the windscreen, cut to length and attach to spindle A.

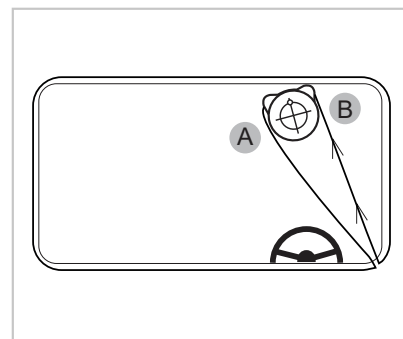

**STEP 1:**

Cut from the starting point at the bottom left to the top left corner.

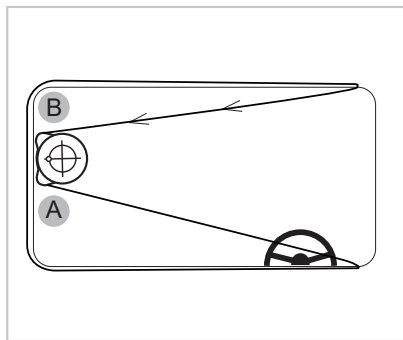

**STEP 2:**

Cut along the roof over the top right corner using spindle B.

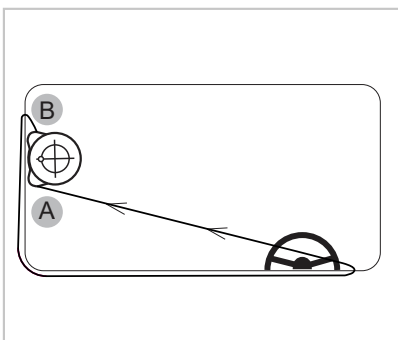

**STEP 3:**

Cut along the dashboard over the bottom right corner using spindle A.

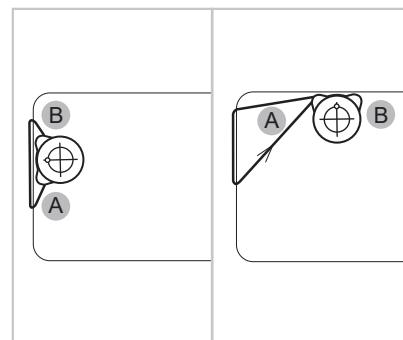

**STEP 4:**

Cut out completely with spindle A.

### ■ WROBK-300K Fibre Line Removal Device Orange Bat Complete kit in plastic case



The Orange Bat from WRD Glass Tools is the ideal solution for quick and damage-free removal of all bonded vehicle windows - both mechanically and manually! The tool can be operated both manually with the hand crank supplied and mechanically with a cordless screwdriver.

The specially developed, extremely strong XN-96 plastic cutting cord is used to cut through the adhesive bead. This not only protects the bodywork and add-on parts, but also enables very fast work.

Additionally needed accessories:

High-torque variable speed cordless drill, e.g.

Cordless Drill/Driver Milwaukee 12 V (item no. ASM-M12) or

Cordless Drill/Driver Milwaukee 18 V (item no. ASM-M18)

*quicklink to the  
product video*



### ■ WROBK-300QC Removal device Orange Bat QC



The new Orange Bat QC from WRD Glass Tools is the ideal solution for quick and damage-free removal of all bonded vehicle windows – both mechanically and manually! The tool can be operated both manually with the hand crank supplied and mechanically with a cordless screwdriver. The specially developed, extremely strong XN-96 plastic cutting cord is used to cut through the adhesive bead. This not only protects the bodywork and add-on parts, but also enables very fast work.

Additionally needed accessories:

High-torque variable speed cordless drill, e.g.

Cordless Drill/Driver Milwaukee 12 V (item no. ASM-M12) or

Cordless Drill/Driver Milwaukee 18 V (item no. ASM-M18)

*quicklink to the  
product video*





■ P6

**Spider Cutting Line P6, 96 m,  
14 pre-marked lengths at 6.85 m on plastic spool**

Special line made of high-tensile, braided polyethylene fibre. The cord has pre-marked lengths which are matched for using it with the Spider cutting tool. The multiple reusable cutting line P6 offers a very high tensile strength and abrasion resistance at a diameter of only 0.6 mm. Thanks to the small diameter this line applies only gentle pressure on the glass so that most windscreens can be removed without breaking.

Application: with SPIDER removal system  
Tensile strength: 110 kg (1078 N)  
Diameter: 0.6 mm



■ XN-96

**Spider cutting Line XN-96, 96 m**

Special line made of high-tensile, braided polyethylene fibre. The line is designed for use with the Orange Bat & Spider cutting tool. The multiple reusable cutting line XN-96 offers a very high tensile strength and abrasion resistance at a diameter of 0.85 mm. In contrast to the P6 and P8 cutting lines, this line has no marked sections!

Application: with Orange Bat & SPIDER system  
Tensile strength: 145 kg (1421 N)  
Diameter: 0.85 mm

## ■ P8



### Spider Cutting line P8, 96 m, 14 pre-marked lengths at 6.85 m on plastic spool

Special line made of high-tensile, braided polyethylene fibre. The cord has pre-marked lengths which are matched for using it with the Spider cutting tool. The multiple reusable cutting line P8 offers a very high tensile strength and abrasion resistance at a diameter of 1.0 mm

Application: with SPIDER removal system & Orange Bat  
Tensile strength: 165 kg (1618 N)  
Diameter: 1.0 mm

## ■ P10



### Spider cutting line P10

Special line made of high-tensile, braided polyethylene fibre. The cord are matched for using it with the Orange Bat & Spider cutting tool. The multiple reusable cutting line P10 offers a very high tensile strength and abrasion resistance at a diameter of 1,2 mm. Unlike to the cutting lines P6 and P8 this line has no pre-marked sections!

Application: with BISON, SPIDER removal system & Orange Bat  
Tensile strength: 192 kg (1882 N)  
Diameter: 1.2 mm



■ **TS-135**

**ProGlass Cutting Line TS, Ø 0.5 mm, 135 m on plastic spool**

Special line made of high-tensile, braided polyethylene fibre. Thanks to the very small diameter of only 0.5 mm this cutting line can be pulled manually (with handles TSG or DGL). But it can also be used with the SPIDER cutting tool, e. g. for cutting-out a glass that is installed very tight to the pinchweld. However, in that case the line could probably not be used more than once.

Application: manual pulling or with SPIDER removal system  
 Tensile strength: 95 kg (930 N)  
 Diameter: 0.5 mm

■ **DBP-1824-WSP**

**Dashboard Protector for WRD Spider approx. 230 x 240 mm**



Clear transparent Dashboard Protector from the SPIDER kit as a single/replacement part.

Dimensions: 230 x 240 mm

■ **DBP-3316-WSP**

**Dashboard Protector for WRD Spider approx. 330 x 160 mm**

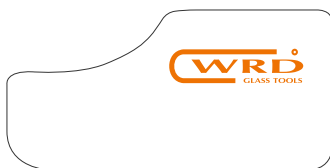

Clear transparent Dashboard Protector for the SPIDER kit as an accessory part.

Dimensions: approx. 330 x 160 mm

■ **DBP-4024-WSP**

**Dashboard Protector for WRD Spider approx. 400 x 240 mm**

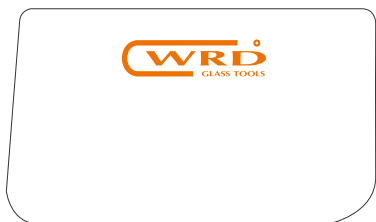

Clear transparent Dashboard Protector for the SPIDER kit as an accessory part.

Dimensions: approx. 400 x 240 mm



■ **AS-150-M** **Anchor Suction Cup Ø 150 mm**



The vacuum cup with clamp screw is used for the secure fixation of the loose cord end when working with the SPIDER and Orange Bat removal system. For all other job with line or wire where a solid anchoring is needed.



■ **AS-115-K** **Anchor Suction Cup Ø 115 mm (plastic) for WRD Spider**

The vacuum cup with clamp screw is used for the secure fixation of the loose cord end when working with the SPIDER and Orange Bat removal system.



■ **DST-757-WSP** **Cutting Line Threader**  
**Length: 340 mm**

Cutting Line Threader from WRD Glass Tools with a flexible blade made of spring steel. Just lay the Spider cutting line over the notched tip and pass it through the polyurethane bead by pushing the tool from the inside to the outside.

Length: 340 mm



■ **MH-140-WSP** **Mini Hook 140 mm**

The mini hook with its double bent tip facilitates grabbing the cutting line from the pinchweld.

■ **MS-180-WSP Cutting line install tool**



A handy install tool for the SPIDER, Orange Bat & Bison removal system with two different shaped ends. The notch on the one side allows you to lay the cutting line in difficult spots like e. g. at the bottom corners of many windscreens. The eye on the other side is suitable for laying the cutting line fast and easy under sealing lips and encapsulations.

■ **WRD-ISC-O Cutting line install tool with cutter**



A handy install tool for the SPIDER, Orange Bat & Bison removal system with two different shaped ends. The notch on the one side allows you to lay the cutting line in difficult spots like e. g. at the bottom corners of many windscreens. The curved notch on the other side is suitable for laying the cutting line fast and easy under sealing lips. With integrated cutter blade for cutting the cord to length (blade not replaceable).

■ **WRD-LD Line & wire dispenser**



Small and handy holder with suction cup. For easy fixing and unwinding of line and wire spools. The suction cup and small size make it easy to attach anywhere.



■ **W-1414****Angle drive 1/4" for WRD Spider**

Angle gear drive for using the Spider removal tool in constricted areas (e.g. for the removal of side glasses or backlites).

Dimensions (LxWxH): 170 x 60 x 25 mm

Gear Ratio: 1.285  
Torque (max.): 60 N

■ **WRD-AD2****Angle drive 1/4" for WRD Spider**

Angle gear drive for using the Spider removal tools in constricted areas (e.g. for the removal of side glasses or backlites). Because of the small size very flexible usable.

Dimensions (LxWxH): 75 x 33 x 26 mm

■ **FBH-190****Flexible bit holder for WRD Spider**

The extended flexible bit holder enables you to cut-out small quarter glasses or strongly curved backlites with the WRD Spider. Due to the high torque force occurring in the cut-out process this component is not suitable for long-term work. For a continuous operation we recommend the angle drive W-1414.

Length: approx. 190 mm

■ **DSF-075****Wire/Cord guiding needle Package of 10 pieces**

Guide Pins are used from the outside in the PU bead, a must to guide the wire or line into the right position. Especially by windshield overhanging the pinchweld at bottom.

Total length: 75 mm



■ **WRD-4RD**

**Quarter Glass Removal Kit**

Designed for safe and efficient side glass panel extraction. Small form factor allows for use in wide range of small panels and applications. The WRD 4" Dock uses high tack 3M pads to temporary fasten a winding point to glass panels or directly to vehicle surfaces.

Kit contains:

- Removal Dock Base Ø 102 mm
- Removal Dock Spindle height 50 mm
- 3M Adhesive Pads (9 pcs)
- Molding Protectors (10 pcs)
- Hex Bit Long
- Hex Bit Short
- Tool Case
- Instruction Manual

■ **WRD-DPS**

**Molding Protector package of 10**

The Molding Protector-Card are used to cover Moldings by removal. For each glass demension and shape the card are used continuous fixed as needed under the Molding.

Dimensions (LxWxH): 154 x 56 x 0,35 mm



■ **ASM-M12**



**Cordless Drill/Driver Milwaukee  
incl. two battery packs (12.0 V Li-Ion / 2.0 Ah)**

- Milwaukee® high performance sub compact percussion drill measures 187 mm in length making it ideal for working within confined spaces
- REDLINK™ overload protection electronics in tool and battery pack deliver best in class system durability
- 10 mm metal chuck for quick bit changes and bit retention
- Optimised handle for better control and improved grip
- Individual battery cell monitoring optimises tool run time and ensures long term pack durability
- On board fuel gauge and LED light - added user convenience and illumination in low lit working conditions
- REDLITHIUM-ION™ battery pack provides superior pack construction, electronics and fade-free performance to deliver more run time and more work over pack life
- Flexible battery system: works with all Milwaukee® M12™ batteries
- Included: Suitcase, Charger, 2 Battery, Belt clip

■ **ASM-M18**



**Cordless Drill/Driver Milwaukee  
incl. two battery packs (18.0 V Li-Ion / 2.0 Ah)**

- Cordless Drill/Driver Milwaukee M18 incl. two battery packs (18.0 V Li-Ion / 2.0 Ah)
- Compact percussion drill measures 145 mm in length making it ideal for working within confined spaces
- REDLINK™ overload protection electronics in tool and battery pack deliver best in class system durability
- 13 mm metal chuck for quick bit changes and bit retention
- 60,5 Nm torque optimal combination off power and handiness
- On board fuel gauge and LED light
- REDLITHIUM-ION™ battery pack provides superior pack construction, electronics and fade-free performance to deliver more run time and more work over pack life
- Flexible battery system: works with all Milwaukee® M18™ batteries
- Included: Suitcase, Charger, 2 Battery, Belt clip

■ TSG-400

**Cutting Line Handles, set of 2 pieces**

Pull handle from WRD Glass Tools in the design of the Spider removal tool. With the ergonomically shaped pull handles the fibre line is clamped reliably and hence can be used also for manual cutting of adhesive beads as well as for the removal of spoilers, trims, badges, antenna covers, etc. With useful PVC suction cup for safe „parking“ of the handle on all smooth surfaces.



■ TSG-401

**Cutting Line Handle, single**

Pull handle from WRD Glass Tools in the design of the Spider removal tool. With the ergonomically shaped pull handle the fibre line is clamped reliably and hence can be used also for manual cutting of adhesive beads as well as for the removal of spoilers, trims, badges, antenna covers, etc. With useful PVC suction cup for safe „parking“ of the handle on all smooth surfaces.



### ■ ESS-150

#### ProGlass One Man Cutting Line Tool Kit ESS

Tool kit for the manual cut-out of bonded vehicle glazing and attached parts with cutting line by only one person.

Thanks to the small diameter the ProGlass cutting line TS can also be operated manually. For cutting out windcreens (or other bonded glasses and attached parts) by only one person this kit contains a 150 mm diameter suction tool with a recessed arm and a fixing point for the cutting line. Attached to the inside of a windscreen this suction tool will hold the line end securely while you cut through the adhesive by pulling with the pull handle from outside.

Kit contains:

- 1 suction cup with cutting line fixing point (item no. ESS-150)
- 1 ProGlass cutting line, 135 m (item no. TS-135)
- 1 wire threader (item no. DST-210)
- 1 cutting line handle with suction cup (item no. DGL-201TS)



### ■ DGL-201TS

#### Cutting Line Handle with suction cup

The fixed suction cup allows you to stick this handle to the glass or even the painted car body. So you can go around the vehicle's front and grab it from the other side easily. The handle will not fall down and hit the car body.

The handle is made of shock resistant plastic, sleeve and shaft are made of chrome-plated metal. Suction cup made of clear PVC.



■ VIP-1138

**Cut-Out System Equalizer Viper tool kit in soft carry case**

The Equalizer® Viper™ is a wire/line removal device designed for small quarter glass removals, but can also be used on windshields and back glasses. It's small, light, and easy to maneuver. Simply use a 1/2" drive ratchet with a 1-1/8" socket slipped over the shaft of the tool to rotate the wire reel. The double direction capability of the reel allows for optimum use and the magnetic points on the ratchet shaft ensure that your ratchet stays firmly attached to the tool, even in steep/vertical scenarios.

Kit Includes:

- 1 Viper Tool (Includes 1/2" Drive Ratchet & 1-1/8" Socket)
- 1 Center Start
- 1 Mini Anchor
- 1 Clear Dash Protector
- 1 Roll of Squire™ Wire
- 1 Spool of RipCord
- All packaged in a soft carry case with foam liner.
- Wire/Cord Guiding Needles
- Pointed Pliers

*quicklink to the product video*



■ RAP-F22

**Equalizer Raptor removal tool**

The Equalizer® Raptor™ is a wire/line removal device designed for small quarter glass removals, but can also be used on windshields and back glasses.

It's small, light, and easy to maneuver. Simply operate the tool manually with the ratchet included with the kit. Include a Constant Vacuum Cup per a electric pumping system which hold the tool on the glass. The double direction capability of the reel allows for optimum use and the magnetic points on the ratchet shaft ensure that your ratchet stays firmly attached to the tool, even in steep/vertical scenarios.



## ProGlass Sawing and Cutting Wires

It was in the seventies when the first passenger cars in Europe were manufactured with a bonded windscreen and the garages were faced with a problem: How could they remove the windscreen from the vehicle without smashing the glass with a hammer?

The first solution was found by using piano wire. On the one hand these wires were thin and on the other hand solid enough. Two pieces of wood had to suffice as handles to hold the wire ends – by that the bonding could be cut through and the glass be taken out in one piece. From this, over the years, a braided wire – similar to our today's Sawing Wire SD – was developed. That is why this type of wire is still known as “piano wire”.

Another frequently used thing in these days was “cheese wire”, thus a wire made for cutting cheese. Although this term is also still used by many technicians the current cut-out wires for bonded auto glass have not a lot in common with the products used in former times.

But this very day sawing and cutting wires still are the most commonly used tool for cutting out bonded auto glass. In our range we carry four different types of metal wires with different cross-sections and sizes. Depending on the application and personal liking every auto glass technician will find his favourite wire on the following pages.





■ SD-02

**ProGlass Sawing Wire SD,  
Ø 0.80 mm, ring at 2.0 m**

■ SD-22

**ProGlass Sawing Wire SD,  
Ø 0.80 mm, 22 m on plastic spool**

■ SD-44

**ProGlass Sawing Wire SD,  
Ø 0.80 mm, 44 m on plastic spool**

ProGlass sawing wire is made of three resistant, brass-plated steel wires that are braided to one strand. The result is a very stable and still flexible sawing wire with a diameter of 0.80 mm. Because of its sawing action this wire is especially good for extra wide or tough bondings.

The wire is held on the plastic spool by a wide rubber band that makes it easy to spool off and cut a required portion while the remaining wire is safely held on the spool.

Application: to saw only  
Tensile strength: 110 kg (1078 N)



■ DD-02



■ DD-50

**ProGlass Cut-Out Wire DD,  
triangular 0.8 x 0.8 mm, ring at 2.0 m**

**ProGlass Cut-Out Wire DD,  
triangular 0.8 x 0.8 mm, 50 m in cardboard box**

Due to the pointed cutting angle of 60° the ProGlass triangular cut-out wire has a particularly good cutting ability. To avoid damages to the painted car body and to the interior this cutting wire should be used mainly for cutting easily accessible bondings.

Application: to pull only

Tensile strength: 75 kg (736 N)

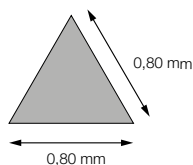



■ **VKD-02**

**ProGlass Cut-Out Wire VKD,**  
squared 0.6 x 0.6 mm, ring at 2.0 m

■ **VKD-22**

**ProGlass Cut-Out Wire VKD,**  
squared 0.6 x 0.6 mm, 22 m on plastic spool

■ **VKD-44**

**ProGlass Cut-Out Wire VKD,**  
squared 0.6 x 0.6 mm, 44 m on plastic spool

Because of its sharp edges this wire has the best cutting action when it is pulled - it is not made for sawing as it would break too fast! To avoid damages to the painted car body and to the interior squared cutting wire should be used mainly for cutting easily accesible bondings.

The wire is held on the plastic spool by a wide rubber band that makes it easy to spool off and cut a required portion while the remaining wire is safely held on the spool.

Application: to pull only  
Tensile strength: 70 kg (686 N)

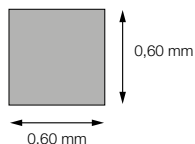



■ **XKD-02**

**ProGlass Cutting Wire XKD,**  
squared 0.7 x 0.7 mm, ring at 2.0 m

■ **XKD-22**

**ProGlass Cutting Wire XKD,**  
squared 0.7 x 0.7 mm, 22 m on plastic spool

■ **XKD-44**

**ProGlass Cutting Wire XKD,**  
squared 0.7 x 0.7 mm, 44 m on plastic spool

The tensile strength of ProGlass XKD cutting wire is by 36% higher than of VKD cutting wire. Therefore this square wire is especially good for cutting double beads or extremely wide polyurethane beads. Thanks to its high tensile strength and the excellent cutting ability this wire works also great with cutting systems like the Roll-Out, CUT-IT, Viper.

The wire is held on the plastic spool by a wide rubber band that makes it easy to spool off and cut a required portion while the remaining wire is safely held on the spool.

Application: to pull only  
Tensile strength: 95 kg (931 N)

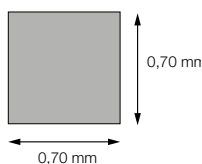



■ **ADR-300**

**FEIN Cutting Wire 300 m**

Replacement wire for FEIN SuperWire cutting system

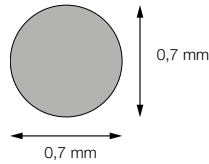

■ **DSS-704**

**ProGlass Wire Cutting Kit DSS with squared and braided wire, in 5 parts**

Kit contains:

- 1 T-handle wire threader (item no. DST-733)
- 1 pair of wire handles (item no. DGL-200)
- 1 ProGlass sawing wire, 22 m (item no. SD-22)
- 1 ProGlass cutting wire, 22 m (item no. VKD-22)



■ **SDK-202**

**ProGlass Wire Cutting Kit SDK with braided wire, in 4 parts**

Kit contains:

- 1 wire threader (item no. DST-125)
- 1 pair of wire handles (item no. DGL-200)
- 1 ProGlass sawing wire, 22 m (item no. SD-22)



■ **VKS-202**

**ProGlass Wire Cut-Out Kit VKS with squared wire, in 4 parts**

Kit contains:

- 1 wire threader (item no. DST-125)
- 1 pair of wire handles (item no. DGL-200)
- 1 ProGlass cutting wire, 22 m (item no. VKD-22)

### ■ EDS-150



### ProGlass One Man Wire Cut-Out Tool Kit EDS

The 150 mm diameter sucker holds the wire absolutely reliable in place and takes over the part of the second person!

Very easy and fast attachment of the bell-shaped sucker by merely pressing it against the glass. The wire is driven very close to the glass to avoid damages to the dash board or interior linings.

Adapted for squared and triangular wire (not for sawing wire!)

Kit contains:

- 1 suction cup with wire fastener (item no. EDS-150-S)
- 1 primer/cleaner for suction cups (item no. HRS-100)
- 1 ProGlass Cut-Out Wire DD, triangular 50 m (item no. DD-50)
- 1 ProGlass squared cutting wire, 22 m (item no. VKD-22)
- 1 wire threader (item no. DST-210)
- 1 wire handle with suction cup (item no. DGL-201S)



*quicklink to the product video*



### ■ EDS-150-0

### ProGlass One Man Wire Cut-Out Tool EDS

Kit contains:

- 1 suction cup with wire fastener (item no. EDS-150-S)
- 1 primer/cleaner for suction cups (item no. HRS-100)



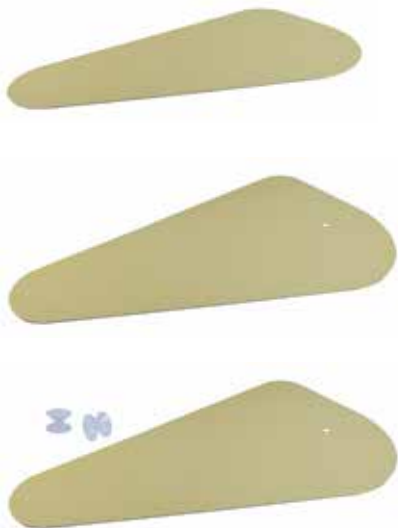

- DBP-4525
- DBP-6030
- DBP-6030-S

**ProGlass Dashboard Protector approx. 49 x 26 cm**

**ProGlass Dashboard Protector approx. 60 x 30 cm**

**ProGlass Dashboard Protector with 2 suction cups approx. 60 x 30 cm**

The Dashboard Protector is made of a 2 mm plastic material. The elastic plastic material adapts to all curves and is at the same time very imperishable and strong so that all cutting and sawing wires slide along easily.

This tool is the perfect companion to cut out glasses using wire/line. Thanks to the special shape it can be used practically on all sides and corners of all cars. Push the board between dashboard/interior trim and glass until it touches the adhesive bead. By that you will not only avoid any kind of damages to the sensible surfaces of interior parts but also protect the VIN plate and the pinchweld edges.



- DBP-3725



**Dashboard Protector approx. 37 x 25 cm**

The Dashboard Protector is made of a 2 mm plastic material. The elastic plastic material adapts to curves and is at the same time very imperishable and strong so that all cutting/sawing wires and line slide along easily. This tool is the perfect companion to cut out glasses using wire and line. Push the board between dashboard/interior trim and glass until it touches the adhesive bead. By that you will not only avoid any kind of damages to the sensible surfaces of interior parts but also protect the VIN plate and the pinchweld edges.

- DBP-4530-SET **ProGlass Dashboard Protector Set in 4 parts**



The Dashboard Protector Set consists of 2 small and 2 big boards made of 2.5 mm thick plastic material. One small and one big board are curved to fit all curved parts inside the vehicle. This tool is the perfect companion to cut out glasses using wire and line. Push the board between dashboard/interior trim and glass until it touches the adhesive bead. By that you will not only avoid any kind of damages to the sensible surfaces of interior parts but also protect the VIN plate and the pinchweld edges. Approx. 27 x 20 cm + 45 x 30 cm.

■ **DH-280**

**ProGlass Wire Hold**  
**approx. 300 mm long, powder-coated steel**

Simple tool to protect the interior trims when cutting out a bonded vehicle glass with wire/line.

The wire hold is fixed with its two suction cups from the inside of the glass, close to the glasses edge. The cutting, sawing wire or line is thereby guided closely to the glass and can not cut into A-pillar trims or the roof lining.



■ **DP001P00**

**ICOR Dashboard Protector,**  
**set of 2 pieces, approx. 62,5 x 24 cm**

Material: Plastic

Dimensions: 62,5 x 24 x 0,18 cm



■ **DP001P01**

**ICOR Protective Board for A-pillars**  
**and roofliners, approx. 40 x 10 cm**

Material: Plastic

Dimensions: 40 x 10 x 0,18 cm





■ DFS-100

**Wire Guiding Spatula with wooden handle, 100 mm wide blade**

The spatula is very practical to guide the wire/line from inside the vehicle. This tool is especially helpful to lift the wire/line over positioning pins or to loosen these pins from the glass.



■ ULR-120

**ProGlass Guide Roller With Pump Cuction Cup**

- for guiding the cutting wire/line from inside of the vehicle
- leading the wire in an optimized angle facilitates cutting
- secure mounting to the glass with integrated vacuum pump
- suitable for manual use as well as for wire cutting tools
- suction cup Ø 120 mm



■ ULR-150

**ProGlass Guide Roller With Suction Cup**

- for guiding the cutting wire/line from inside of the vehicle
- leading the wire in an optimized angle facilitates cutting
- easy mounting by merely pressing the bell-shaped suction cup against the glass
- suitable for manual use as well as for wire cutting tools
- suction cup Ø 150 mm



■ MAC-1125

**Mini Anchor Cup**

The mini anchor with loop allow a secure fixing from all wire or cordless ends by working with diverse cutting systems. Trough his little diameter from only Ø 55,0 mm perfect to be used by small quarter glass removals.

### ■ DGH-300

#### ProGlass Wire Guide

The wire guide can prevent you from damaging the dash board, interior trims or the painted body of the vehicle. Length of the flat tip: 7 cm, overall length of the tool is approx. 34 cm. Knurled head screw with thread in M4 for secure fastening of the wire without the use of tools.



### ■ DGS-301

#### ProGlass Wire Guide and Wire Handle

Kit contains:

- 1 wire guide (item no. DGH-300)
- 1 wire handle (item no. DGL-201)

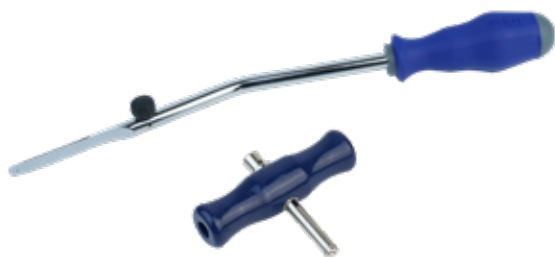

### ■ DHL-300

#### ProGlass Wire Guide, long version

The extra long wire guide also works with the latest Mini-Vans and Coupés because his flat tip is real 16 cm long! Overall length of the tool is ca. 38 cm. Knurled head screw with thread in M4 for secure fastening of the wire without the use of tools.



### ■ SPZ-160

#### Pointed Pliers With Wire Cutter 170 mm long

Pointed pliers make it easy to grip the wire end after it has been pierced through the adhesive bead. These pointed pliers do also have an integrated wire cutter.





■ DGL-200

**Wire Handles, set of 2 pieces**

These self-locking wire handles have an excellent grip on each type of wire.

The handle is made of shock resistant plastic, sleeve and shaft are made of chrome-plated metal.



■ DGL-201

**Wire Handle, single**

This self-locking wire handle has an excellent grip on each type of wire.

The handle is made of shock resistant plastic, sleeve and shaft are made of chrome-plated metal.



■ DGL-201S

**Wire Handle With Suction Cup**

The fixed suction cup allows you to stick this handle to the glass or even the painted car body. So you can go around the vehicle's front and grab it from the other side easily. The handle will not fall down and hit the car body. The wire will not unnecessarily touch the painted car body or other damageable surfaces.



■ TWH-500

**Wire Handles TightWire, set of 2 pieces**

Wire handles with screw-clamp fastening. For quick and secure fixing of all sawing and cutting wires as well as cutting lines.

Unscrew the handle, insert the wire end into the hole and bend it over, pull it around the bolt at least one time and twist the handle back together tightly.

Made of aluminium with red vinyl cover.

■ **DST-125**

**T-Handle Wire Threader, small length: 125 mm**

■ **DST-210**

**T-Handle Wire Threader, small length: 210 mm**

Hollow needle made of steel with a T-handle made of aluminium to pierce the polyurethane bead and pass the wire through.

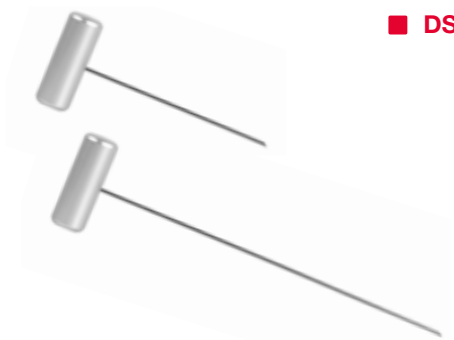

■ **WS-782**

**O-Handle Wire Threader, small, Length: 125 mm**

■ **WS-782P**

**O-Handle Wire Threader, long, Length: 230 mm**

Hollow needle made of steel with aluminium handle to pierce the polyurethane bead and pass the wire through.

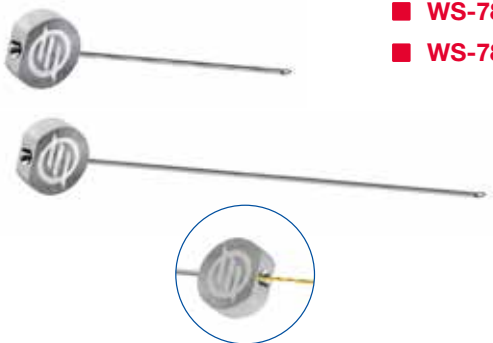

■ DST-733

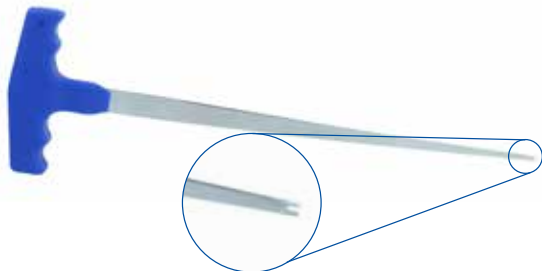

**T-Handle Wire Threader, large**  
**Length: 325 mm**

Very solid wire/line threading device with a flexible blade made of spring steel. Just lay the wire in the notched tip and pass it through the polyurethane by pushing the tool from the inside to the outside.

■ DST-410

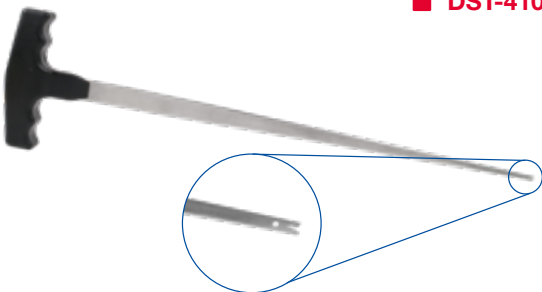

**T-Handle Wire Threader, extra long,**  
**Length: 410 mm**

Very solid wire/line threading with T-handle and extra long spring steel blade. The wire is placed over the notched tip and through from the inside the adhesive bead is stung, or after piercing from the outside through the eye (Ø 1.6 mm) and with the tool inside drawn.

■ DST-745

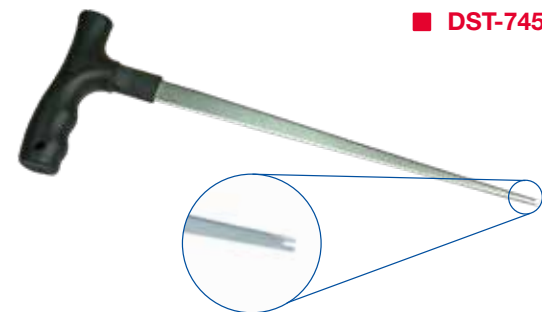

**L-handle Wire Threader, large**  
**Length: 340 mm**

Very solid wire/line threading device with a flexible blade made of spring steel. Just lay the wire in the notched tip and pass it through the polyurethane by pushing the tool from the inside to the outside.

■ DST-757

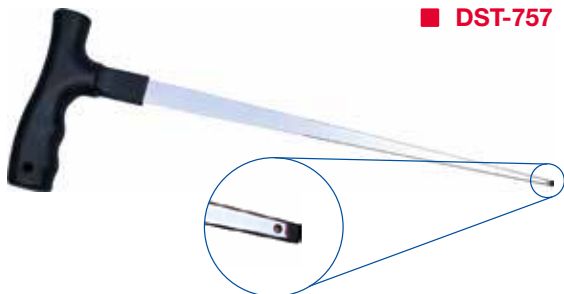

**L-Handle Wire Threader, large**  
**Length: 340 mm**

Very solid wire/line threading device with a flexible blade made of spring steel. Push the tip through the polyurethane from the inside to the outside, pass the wire through the eye (Ø 1.6 mm) and pull the tool back.





■ **SMQ-425**

**ProGlass Pull Knife Kit in plastic case**

Kit contains:

- 1 ProGlass pull knife (item no. ZMQ-425)
- 1 stainless steel blade 25 mm (item no. UW-725)
- 1 stainless steel blade 38 mm (item no. UW-738)
- 1 scraper blade 19 mm (item no. SK-119)
- 1 foam lined plastic case 240 x 215 x 45 mm



■ **ZMQ-425**

**ProGlass Pull Knife with quick release system, with neoprene handle cover**

- ergonomically shaped pull knife for optimum power transmission
- non-skid and protecting covers to avoid scratches
- blade exchange within seconds
- includes 1 stainless steel blade 25 mm long



■ **ZMX-400**

**ProGlass Pull Knife with quick release system**

- ergonomically shaped pull knife for optimum power transmission
- corrugated handle design with maximum grip
- blade exchange within seconds
- includes 1 stainless steel blade 25 mm long



■ **ZGL-195**

**ProGlass Pull Handle with neoprene cover**

Replacement pull handle, suitable for the ProGlass pull knives ZMK-110, ZML-395, ZMQ-425 and ZMX-400.



■ **ZFK-3007**

**ProGlass Pull Knife / Pinchweld Scraper Kit**

Complete tool kit for cutting-out bonded vehicle glasses and for preparing the pinchweld for the replacement glazing.

Kit contains:

- UltraWiz Pull Knife with fast release system
- UltraWiz Serrated Blade, 19 mm long
- UltraWiz Serrated Blade, 25 mm long
- UltraWiz Serrated Blade, 38 mm long
- Scraper, 120 mm long
- 10 Scraper Blades, 18 mm wide
- Parer Blade, Ø 6 mm
- Parer Blade, Ø 12 mm
- foam lined plastic case

■ **UW-3007**

**UltraWiz Pull Knife with fast release lever mechanism, with flexible pull handle**



UltraWiz Lever Pull Knife with ergonomic handle design and unique fast release lever mechanism. Opening the lever releases the blade immediately. The blade can be adjusted stepless within a wide range. By closing the lever the blade is held in position securely. Includes 1 pull knife blade 25 mm long.

■ **UW-3001**

**UltraWiz Pull Knife with flexible pull handle**



UltraWiz pull knife with ergonomic handle design. The lateral locking screw makes blade replacements faster than with standard pull knives. Includes 1 pull knife blade 25 mm long.

■ **UW-3001RK**

**UltraWiz Pull Handle**



Replacement pull handle for the UltraWiz pull knives UW-3001 und UW-3007.



■ **ZKS-110**

**ProGlass Standard Pull Knife, short model**

Rugged and proved standard pull knife with flexible pull handle. The short handle facilitates working in constricted area (e.g. below the bonnet). Includes 1 pull knife blade 25 mm long.

total length: 105 mm (incl. blade /excl. handle)



■ **ZMK-110**

**ProGlass Pull Knife with neoprene cover, short model**

Rugged and proved standard pull knife with flexible pull handle. The short handle facilitates working in constricted area (e.g. below the bonnet). With neoprene covered handles and PVC covered pull cable for better handling and to avoid scratches. Includes 1 pull knife blade 25 mm long.

total length: 110 mm (incl. blade /excl. handle)



■ **ZML-395**

**ProGlass Pull Knife with neoprene cover**

Rugged and proved standard pull knife with flexible pull handle. With neoprene covered handles and PVC covered pull cable for better handling and to avoid scratches. Includes 1 pull knife blade 25 mm long.

total length: 170 mm (incl. blade /excl. handle)



■ **ZMS-382**

**ProGlass Standard Pull Knife**

Rugged and proved standard pull knife with flexible pull handle. Includes 1 pull knife blade 25 mm long.

total length: 165 mm (incl. blade /excl. handle)



■ **WRD-RK**

### **Rhino Knife Cold Knife with 1 x serrated 25 mm blade**

Very stable and handy cold knife with magnetized blade insertion for quick and easy change. Through his special design you can pull and push the knife by using relatively easily. Includes 1 serrated blade 25 mm long.



■ **UW-3055-K**

### **UltraWiz UltraReach Cold Knife**

Bow type knife with non-slip handle for a good grip and controlled cutting. Greater reach thanks to the length-adjustable handle. The bow handle can be swiveled 45 ° left and right and can therefore be used flexibly. Easy blade change by pushing the blade in and out. Suitable for pulling and pushing, can be used on the left & right. Suitable for all standard cold knife blades.

Supplied with 1 blade 25 mm.



■ **ZK-35**

### **ZipKnife Cold Knife, 220 x 150 mm**

■ **ZK-45**

### **ZipKnife Cold Knife, Compact, 225 x 80 mm**

ZipKnife Cold Knife has a ergonomic bow type handle for a optimum hold and controlled cut. Easy blade exchange per pull and push the blade. The Cold Knife is usable on both ways left and right per pull and push. Uses all standard cold knife blades. Advantages of the compact version: Facilitates working in narrow spaces, e.g. under the hood.

Note: shipped without blade!





■ **UW-109**

**UltraWiz Pull Knife Blade 9 mm long package at 5 pieces**

■ **UW-1000-P**

**UltraWiz Pull Knife Blade 9 mm long package at 10 pieces**



■ **UW-119**

**UltraWiz Standard Pull Knife Blade 19 mm long package at 5 pieces**

■ **UW-1001-P**

**UltraWiz Standard Pull Knife Blade 19 mm long package at 10 pieces**



■ **UW-125**

**UltraWiz Standard Pull Knife Blade 25 mm long package at 5 pieces**

■ **UW-1002-P**

**UltraWiz Standard Pull Knife Blade 25 mm long package at 10 pieces**



■ **UW-132**

**UltraWiz Standard Pull Knife Blade 32 mm long package at 5 pieces**

■ **UW-1003-P**

**UltraWiz Standard Pull Knife Blade 32 mm long package at 10 pieces**



■ **UW-138**

**UltraWiz Standard Pull Knife Blade 38 mm long package at 5 pieces**

■ **UW-1004-P**

**UltraWiz Standard Pull Knife Blade 38 mm long package at 10 pieces**

The Standard series from UltraWiz marks the worldwide industry standard for pull knife blades. Made of carbon steel (a low-alloy steel with a high carbon content) these blades offer a fine edge in combination with a good durability and hardness.

■ **UW-6991**

**UltraWiz Serrated Blade, 19 mm long,  
package at 5 pieces**

■ **UW-6992**

**UltraWiz Serrated Blade, 25 mm,  
long package at 5 pieces**

■ **UW-6994**

**UltraWiz Serrated Blade, 38 mm long,  
package at 5 pieces**



The advantages of a serrated blade are already known from various powered cutting tools. With these new serrated pull knife blades UltraWiz has proven that serrations also offer benefits on of hand-operated blade.

The sharp teeth pierce the polyurethane when pulling the blade. In connection with the thin cutting edge this clearly facilitates the cutting process. At the same time the blade can be re-sharpened on the outside without losing its serrations. Thus this blade has a very long service life.

■ **UW-519**

**UltraWiz Pull Knife Blade, extra thin, 19 mm long  
package at 5 pieces**

■ **UW-5001-P**

**UltraWiz Pull Knife Blade, extra thin, 19 mm long  
package at 10 pieces**

■ **UW-525**

**UltraWiz Pull Knife Blade, extra thin, 25 mm long  
package at 5 pieces**

■ **UW-5002-P**

**UltraWiz Pull Knife Blade, extra thin, 25 mm long  
package at 10 pieces**

■ **UW-538**

**UltraWiz Pull Knife Blade, extra thin, 38 mm long  
package at 5 pieces**

■ **UW-5004-P**

**UltraWiz Pull Knife Blade, extra thin, 38 mm long  
package at 10 pieces**

The UltraThin series from UltraWiz has a 40% thinner cutting edge than the standard blades. Therefore these blades cut more easily through adhesive beads but still offer the same durability and hardness than the UltraWiz Standard blades.



- **UW-51C1** UltraWiz Paint Protection Blades 19 mm long package at 5 pieces
- **UW-51C1-P** UltraWiz Paint Protection Blades 19 mm long package at 10 pieces
- **UW-51C2** UltraWiz Paint Protection Blades 25 mm long package at 5 pieces
- **UW-51C2-P** UltraWiz Paint Protection Blades 25 mm long package at 10 pieces
- **UW-51C4** UltraWiz Paint Protection Blades 38 mm long package at 5 pieces
- **UW-51C4-P** UltraWiz Paint Protection Blades 38 mm long package at 10 pieces

This blade series has a smooth plastic coating on the back, so if the blade touches the paint, it will not be damaged. The coating is very tough and will not easily rub off. The blade is based on the UltraWiz UltraThin series, so it is one of the thinnest blades in the industry.



- **UW-719** UltraWiz Stainless Steel Blade, 19 mm long
- **UW-7001-P** UltraWiz Stainless Steel Blade, 19 mm long package at 10 pieces
- **UW-725** UltraWiz Stainless Steel Blade, 25 mm long
- **UW-7002-P** UltraWiz Stainless Steel Blade, 25 mm long package at 10 pieces
- **UW-738** UltraWiz Stainless Steel Blade, 38 mm long
- **UW-7004-P** UltraWiz Stainless Steel Blade, 38 mm long package at 10 pieces

With the Stainless Steel series in the year 2000 UltraWiz presented the first coined stainless steel blade of the auto glass industry. The blade combines the known advantages of the Standard series with an improved durability, a better consistency and a longer lasting sharp edge. As each of these blades can be used for a very long time we offer them not only in the original package at 10 pieces but also as single packaged blades.

## ■ UWS-6

**UltraWiz Blade Assortment, in 6 parts**

Kit contains:

- 1 UltraWiz Pull Knife Blade 19 mm
- 1 UltraWiz Pull Knife Blade 25 mm
- 1 UltraWiz Pull Knife Blade 38 mm
- 1 UltraWiz Pull Knife Blade, extra thin, 19 mm
- 1 UltraWiz Pull Knife Blade, extra thin, 25 mm
- 1 UltraWiz Pull Knife Blade, extra thin, 38 mm

## ■ UWG-3

**UltraWiz Serrated Blade Assortment, in 3 parts**

Kit contains:

- 1 UltraWiz Serrated Blade 19 mm long
- 1 UltraWiz Serrated Blade 25 mm long
- 1 UltraWiz Serrated Blade 38 mm long

## ■ UWE-3

**UltraWiz Stainless Steel Blade Assortment, in 3 parts**

Kit contains:

- 1 UltraWiz stainless steel blade 19 mm
- 1 UltraWiz stainless steel blade 25 mm
- 1 UltraWiz stainless steel blade 38 mm

■ UW-1012

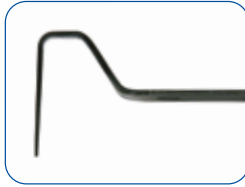

**UltraWiz Special Blade „Offset Clearance“  
package at 5 pieces**

This blade enables cutting around the bottom corners or the bottom edge when the glass is partly covered by fenders and/or the hood. The blade has a cutting length of 25 mm.

■ UW-1022



**UltraWiz Special Blade „Offset Moulding“  
package at 5 pieces**

This blade enables you to release a glass from its moulding when the moulding has been bonded to the pinchweld as a result of excessive use of adhesive. The blade cuts between glass and moulding. After cutting just slide the glass down until it can be removed. After that the moulding can be separated from the pinchweld without damage. The blade has a cutting length of 25 mm.

■ UW-550

■ UW-565



**UltraWiz Pull Knife Blade,extra thin, 50 mm long**

**UltraWiz Pull Knife Blade, 65 mm long**

Due to its special length this blade enables you to cut an adhesive bead that is set back from the glass edge.



- **UW-5500**
- **UW-5501**
- **UW-5502**
- **UW-5503**

**UltraWiz Interior Pull Knife Blade 13 mm, package at 5 pieces**  
**UltraWiz Interior Pull Knife Blade 19 mm, package at 5 pieces**  
**UltraWiz Interior Pull Knife Blade 25 mm, package at 5 pieces**  
**UltraWiz Interior Pull Knife Blade 32 mm, package at 5 pieces**

Finally a blade series that enables you to use your pull knife from inside the vehicle! With these blades you can cut out many side and back glasses with ease.

Don't believe it? Try to cut out the next back glass of a VW Golf III with the 13 mm long blade and you will be surprised. Works also on side glasses.



- **ZKS-150**
- **ZKS-180**

**ProGlass Special Pull Knife Blade, 30 mm long, stainless steel, for set back adhesive beads**  
**ProGlass Special Pull Knife Blade, 60 mm long, stainless steel, for set back adhesive beads**

The unique double-angled shape of this blades enables you to use a pull knife where you could never use it before!

Typical application area of the 60 mm blade are set back adhesive beads that can be found on the bottom side of many windscreens and that could never be reached with a pull knife blade before.

The 30 mm blade is perfect for all other situations with a body superstructure - meaning that the fenders or the hood are covering the glasses edge, making it impossible to use a 90 degree angled blade.





- **ZK-0119**      **Standard Stainless Steel Blade, 19 mm long**
- **ZK-0119-P**    **Standard Stainless Steel Blade, 19 mm long package at 5 pieces**
- **ZK-0125**      **Standard Stainless Steel Blade, 25 mm long**
- **ZK-0125-P**    **Standard Stainless Steel Blade, 25 mm long package at 5 pieces**
- **ZK-0138**      **Standard Stainless Steel Blade, 38 mm long**
- **ZK-0138-P**    **Standard Stainless Steel Blade, 38 mm long package at 5 pieces**

Well-priced stainless steel blade series. The cutting part of these blades is a little bit thinner and the edge is grinded in a different angle than the stainless series from UltraWiz and REID. Therefore they work with less cutting resistance. Because of the thinner material they also bend and twist more easily when cutting through hard adhesive. Anyway they offer a good cost-performance ratio.

- **USS-190**      **Universal Sharpening Stone with handle**



This sharpening stone with plastic handle is ideal for sharpening all pull knife blades, scraper blades, utility blades and power tool blades.

Working is much easier with a sharp blade!

- **WK8DSM**      **Diamond Sharpening Stone 183 x 19 x 5 mm**



Sharpening stone with cranked handle, with a flat side perfect usable for sharpening blades. Evenly distributed monocrystalline diamond grains bonded to a plastic base.



■ **OM-520**



**ProGlass Oscillating Cut-Out Knife „Heavy Duty“ with 1 blade OK-51**

- rugged tool for frequent use
- powerful air motor with 22,000 rpm
- backward facing air exhaust with silencer
- safety throttle to avoid an unintended start of the motor
- delivered with hex key for blade exchange
- blade clamp fits all FEIN blades
- air connection 1/4, air consumption 300 l/min
- max. operating pressure 6.2 bar (90 psi)
- net weight: approx. 1.0 kg

■ **OM-610**



**ProGlass Oscillating Cut-Out-Knife Deluxe with 1 blade OK-51**

Extra low vibration drive for non-tiring work under regular and frequent use.

- rugged air motor with 22,000 rpm
- backward facing air exhaust with silencer
- safety throttle to avoid an unintended start of the motor
- delivered with special key for blade exchange with swivelling and removable extra handle
- blade clamp fits all FEIN blades
- air connection 1/4, air consumption 300 l/min
- max. operating pressure 6.2 bar (90 psi)
- net weight: approx. 1.15 kg



■ **OMS-520**

**ProGlass Auto Glass Cut-Out Knife Kit „Heavy Duty“  
in plastic case**

Kit contains:

- 1 cut-out knife OM-520
- 1 scraper blade OK-50
- 1 of each cutting blade OK-51, OK-52, OK-53 and OK-54
- 1 foam lined plastic case 340 x 275 x 83 mm



■ **OMS-610**

**ProGlass Auto Glass Cut-Out Knife Kit „Deluxe“  
in plastic case**

Kit contains:

- 1 cut-out knife OM-610 with extra handle
- 1 scraper blade OK-50
- 1 of each cutting blade OK-51, OK-52, OK-53 and OK-54
- 1 foam lined plastic case 340 x 275 x 83 mm



■ **OK-50** Scrapper Blade, cranked,  
16 mm wide



■ **OK-51** Cutting blade, straight, cranked  
cutting depth 50 mm



■ **OK-52** Cutting blade, straight,  
cutting depth 35 mm



■ **OK-53** Cutting blade, curved, cranked,  
cutting depth 55 mm



■ **OK-54** Cutting blade, straight, cranked  
immersion length 90 mm, cutting depth 50 mm



■ **OK-55** Cutting blade, serrated, straight, Blade length 37 mm,  
cutting depth 30 mm



■ **OK-56** Cutting blade, straight, Blade length 43 mm,  
cutting depth 30 mm



■ **OK-57** Cutting blade, curved 45°, Blade length 43 mm,  
cutting depth 27 mm

Robust universal blades for oscillating cutters. Made of hardened stainless steel with a 19 mm double-hexagonal adaptor.

The blades are compatible with the current oscillators from Fein, CP, ProGlass, Rodcraft, Equalizer, etc.



■ 51847

**Viper blade, short, L-shaped  
cutting depth 19 mm**

■ 51848

**Viper blade, long, L-shaped  
cutting depth 25 mm**

■ 51849

**Viper blade, extra-long, L-shaped  
cutting depth 38 mm**

These L-shaped blades are used for cutting out bonded vehicle glasses without damaging the neighbouring pinchweld. At the same time Viper blades are very robust and cut through tough adhesive beads, where other blades just give up and break. Made of hardened steel with a 19 mm double-hexagonal adaptor.

The blades are compatible with the current oscillators from Fein, CP, ProGlass, Rodcraft, Equalizer, etc.



■ **DG-322**

**Rotary Joint for air hoses  
air connection 1/4"**

The rotary joint prevents the air hose from damages or early wear-out. Rotatable at 360°.



■ **DLR-160**

**Air Regulator 11 bar (160 psi)  
air connection 1/4"**

Very compact air regulator with pressure gauge to regulate the required working pressure.



■ **PT-321**

**Direct lubricator (not filled)  
air connection 1/4"**

This handy lubricator can be placed between air hose and tool and maintains the tool. Your air tool will get the right amount of oil automatically.

Please order additional: Air Tool Oil ATO-100



■ **ATO-100**

**Air Tool Oil, bottle at 100 ml**

This heavy duty air tool oil can be used for all air tools in our catalogue. Air tools must be oiled daily when used regularly. If you use your tool not regularly you must oil it before and after each use (and run the motor for a few seconds).

The bottle with the long fine tip makes it easy to fill the direct lubricator PT-321.



■ **OP-20F**

**Air Plug with inside thread R 1/4"**



■ **OP-20M**

**Air Plug with outside thread R 1/4"**



■ **OD-20M**

**Air socket with outside thread R 1/4"**

■ **AFSC-22**

**FEIN Battery-Powered Multimaster Automotive AFSC 1.7 Q with quick clamping system, in tool case with accessories**



Kit contains:

- 1 FEIN Battery-Powered Multimaster AFSC 1.7 Q  
10,000-19,500 1/min, net weight (incl. battery) approx. 1.8 kg
- 1 sharpening stone
- 1 protective cover for tool changes
- 2 Li-Ion battery packs 18 V, 5.0 Ah
- 1 battery charger
- 1 plastic tool case

■ **AFSC-22-A**

**FEIN Professional Set For Vehicle Glazing (Battery-Powered)**



Kit contains:

- 1 FEIN Battery-Powered Multimaster AFSC 1.7 Q  
10,000-19,500 1/min, net weight (incl. battery) approx. 1.8 kg
- 3 L-shaped cutter blades, toothed (FB-207)
- 2 L-shaped cutter blades, toothed (FB-208)
- 1 L-shaped cutter blade, toothed (FB-209)
- 1 hook blade (FB-111)
- 1 hook blade (FB-157)
- 2 hook blades (FB-212)
- 1 straight cutter blade Z-bend, with adjustable stop roller (FB-143)
- 1 straight cutter blade, Z-bend, toothed (FB-081)
- 1 sharpening stone
- 1 protective cover for tool changes
- 2 Li-Ion battery packs 18 V, 5.0 Ah
- 1 battery charger
- 1 plastic tool case

■ **BP-AFSC-22**

**Li-Ion Battery 18V, 5.0 Ah for AFSC-22**





■ **FEC-417**

**FEIN Multimaster MM700 1.7 Basic,  
in tool case with accessories**

Kit contains:

- 1 electronic oscillator 450 W  
10,000-19,500 1/min, net weight: approx. 1.45 kg
- 1 blade exchange key
- 1 sharpening stone
- 1 plastic tool case



■ **FEC-417Q**

**FEIN Multimaster MM700 1.7 Q Basic, with quick  
clamping system, in tool case with accessories**

Kit contains:

- 1 electronic oscillator 450 W  
10,000-19,500 1/min, net weight: approx. 1.65 kg
- 1 sharpening stone
- 1 plastic tool case

■ **FEC-417Q-A FEIN Professional Set For Automobile Workshops**



Kit contains:

- 1 FEIN Multimaster FSC 1.7Q Basic (FEC-417Q) in plastic tool case
- 2 hook blades (FB-076)
- 1 hook blade (FB-079)
- 1 hook blade (FB-101)
- 2 L-shaped cutter blades, toothed (FB-207)
- 1 L-shaped cutter blade, toothed (FB-208)
- 1 Hook blade, reinforced (FB-157)
- 1 straight cutter blade, Z-bend, with adjustable stop roller (FB-143)
- 1 shovel-shaped scraper blade with scrape protection coating (form 129)
- 1 HSS saw blade Ø 80 mm (FSB-103)
- 1 stopper knife

■ **FEC-417Q-B FEIN Professional Set For Bus and Truck**



Kit contains:

- 1 FEIN Multimaster FSC 1.7Q Basic (FEC-417Q) in plastic tool case
- 2 straight cutter blades, toothed (FB-073)
- 2 straight cutter blade, Z-bend, toothed (FB-081)
- 1 hook-shaped cutter blade, toothed (FB-217)
- 1 curved cutter blade, Z-bend, toothed (FB-072)
- 2 L-shaped cutter blades, toothed (FB-207)
- 1 L-shaped cutter blade, toothed (FB-209)
- 1 hook blade, toothed (FB-212)
- 1 shovel-shaped scraper blade with scrape protection coating (form 105)
- 1 traction cable with fastening



■ **FB-072**

**FEIN Cutting Blade**  
cranked, length 45 mm, package of 2 pieces



■ **FB-073**

**FEIN Cutting Blade**  
toothed, straight, length\* 56/35 mm, package of 2 pieces



■ **FB-076**

**FEIN Hooked Blade**  
length 24 mm, package of 2 pieces



■ **FB-079**

**FEIN Hooked Blade**  
length 36 mm, package of 2 pieces



■ **FB-081**

**FEIN Cutting Blade**  
cranked, length\* 85/60 mm, package of 2 pieces



■ **FB-101**

**FEIN Hooked Blade**  
length 60 mm, package of 2 pieces



■ **FB-107**

**FEIN Hooked Blade**  
length 60 mm, package of 2 pieces



■ **FB-110**

**FEIN Hooked Blade**  
length 40 mm, package of 2 pieces

\* immersion length/cutting length



■ **FB-123**

**FEIN Cutting Blade**  
cranked, length\* 110/32 mm, package of 2 pieces



■ **FB-157**

**FEIN Hooked Blade,**  
length 60 mm, package of 2 pieces



■ **FB-174**

**FEIN Cutting Blade**  
cranked, length 27 mm, package of 2 pieces



■ **FB-176**

**FEIN Cutting Blade**  
straight, length\* 74/40 mm, package of 2 pieces

■ **FB-194**

**FEIN Cutting Blade**  
straight, length 110 mm, package of 2 pieces



■ **FB-207**

**FEIN Cutting Blade, toothed,**  
L-shaped, length 25.4 mm, package of 2 pieces



■ **FB-208**

**FEIN Cutting Blade, toothed,**  
L-shaped, length 19 mm, package of 2 pieces



■ **FB-209**

**FEIN Cutting Blade, toothed,**  
L-shaped, length 38 mm, package of 2 pieces

\* immersion length/cutting length



■ **FB-210**

**FEIN Hooked Blade, toothed, reinforced U-shaped, length 19 mm, package of 2 pieces**



■ **FB-211**

**FEIN Hooked Blade, toothed, reinforced U-shaped, length 25.4 mm, package of 2 pieces**



■ **FB-212**

**FEIN Hooked Blade, toothed, reinforced U-shaped, length 38 mm, package of 2 pieces**



■ **FB-217**

**FEIN Hooked Blade, toothed cranked, length 38 mm, package of 2 pieces**



■ **FSB-102**

**FEIN Saw Blade  
Ø 63 mm, package of 2 pieces**



■ **FSB-103**

**FEIN Saw Blade  
Ø 80 mm, package of 2 pieces**

\* immersion length/cutting length

■ **ATV-2012**



*quicklink to the product video*



**Equalizer Ambush 20 V (Equalizer® Express® series)**

The Equalizer® Ambush™ is designed to cut through the toughest urethane. A heavy-duty 20-Volt motor provides the power to quickly remove the most difficult glass and with the convenience of the battery, there is no need to worry about finding an electrical outlet or extension cords. It has a rubber over molded comfort grip that allows for optimal comfort and control and a quick release blade clamp that makes it fast and easy to change blades on the fly.

Kit contains:

- 1 Equalizer® Ambush™ Removal Tool
- 1 20-Volt battery DCB-205
- 1 battery charger DCB-105
- 1 Blade BFE-1400
- 1 Instructional DVD
- 1 pair of safety glasses
- 1 heavy-duty plastic carrying case

■ **ES-1406**

**Equalizer® Express® Sheath**

The sheath is the unique, patented idea that allows the Equalizer® Express® to use a flexible blade and still have the strength to cut the toughest polyurethane. All Express® tools use the same sheath.



■ **BFE-1400**

**Equalizer® Express® Blade, standard, wide**



The Equalizer® Express® Blades were developed from daily use on hundreds of different vehicles. The BFE-1400 is the most used size and is perfect for slicing through wide bands of polyurethane. It works well in all places where you plunge cut or angle cut. The BFE-1401 blade is perfect for removing glass that is not broken. The narrow blade is more flexible and puts less stress on the glass.

■ **EHB-186**

**Equalizer® Express® Blade, standard, wide**



Express® HydroBlades have a series of small dimples stamped on the side of the blade that rides against the polyurethane. These dimples are designed to carry cutting lubricant into the polyurethane. The cutting lubricant allows for each stroke of the blade to slide easily through the polyurethane. Besides making the blade cut easier they also save battery life and reduce vibration because of the reduced friction on the blade.

■ **MEH-234**

**Manual Handle for Express® Blades**



With this manual handle you can use any Equalizer Express® Blade as a long knife. The handle is made of aluminum and is 215 mm long (perfect for two handed operation). The blade can be set into the handle at any depth from 20 mm up to 95 mm just by tightening the steel screw into the blade when you have set the blade at the desired depth. Blade not included.

■ **SFE-329**

**Equalizer Blade Sharpener**



A power tool is only as good as its blade! This blade sharpener is perfect for sharpening all nonserrated Equalizer and BTB blades quickly and easily and is a must for every tool box.



**BTBTOOLS**

...not just another  
windscreen tool



- cuts hard, wide and high polyurethane
- adjustable cutting depth control for every blade
- minimum hand/arm vibration



**long blades**

easily reach below any dashboard or hard to reach areas



**short blades**

for good tool control in easy accessible areas



**from outside**

operates as a powered pull knife that allows cutting from outside for extremely fast removal without physical force



**from inside**

the flexible and versatile blades follow curved glass as found for example on hatch glasses, safely remove encapsulated glasses



**small & versatile**

small tool and different blades allow you to work in tight spaces such as small quarter glasses



**also for busses and trains**

thanks to the variety of blades the BTB tool can be used for the removal of all kind of glasses, panels and mouldings

### ■ WKSTR-BX BTB Starter Kit (4 blades) in plastic case

Besides the air tool this kit contains a basic assortment of accessories for cutting out bonded glasses on modern vehicles.



Kit contains:

- heavy duty air tool WK10HD, net weight approx. 1.6 kg
- blades: WK2-S, WK4Z-S, WK27S, WK28M
- adjustable cutting depth control arms: WK11BW5, WK11FW
- accessories: WK-KEY, WK7, WK8DSM, WK9, WK11VEL, WK-GA
- training package: users manual, WK12DVD Introduction & Training DVD
- sturdy plastic case

### ■ WKCLS-BX BTB Classic Kit (7 blades)

Besides the air tool this kit contains an assortment of accessories that enable you to cut out most bonded glasses on modern vehicles with ease.



Kit contains:

- heavy duty air tool WK10HD, net weight approx. 1.6 kg
- blades: WK2-S, WK3, WK24Z-S, WK24ZR-S, WK27S, WK28M, WK6-M
- adjustable cutting depth control arms: WK11AW, WK11BW5, WK11CW, WK11FW
- accessories: WK-KEY, WK7, WK8, WK9, WK11VEL, WK20, WK-GA
- training Package: users manual, WK12DVD Introduction & Training DVD
- sturdy plastic case

■ **WKTEC-BX BTB Technician Kit (11 blades)**



Besides the air tool this kit contains a comprehensive assortment of accessories for fast and simple cutting out of practically all bonded glasses on modern vehicles.

Kit contains:

- heavy duty air tool WK10HD, net weight approx. 1.6 kg
- blades: WK1-S, WK2-S, WK4-S, WK4Z-S, WK4R-S, WK6-M, WK24Z, WK24ZR-S, WK24R-S, WK27S, WK28M
- adjustable cutting depth control arms: WK11AW, WK11BW5, WK11CW, WK11EW, WK11FW
- accessories: WK-KEY, WK7, WK7L, WK8, WK9, WK11VEL, WK20, WK-GA
- training Package: users manual, WK12DVD Introduction & Training DVD
- sturdy plastic case

■ **WKTDM-BX BTB Tradesman Kit (13 blades)**



Besides the air tool this kit contains a comprehensive assortment of accessories for fast and simple cutting out of practically all bonded glasses on modern vehicles including commercial vehicles.

Kit contains:

- heavy duty air tool WK10HD, net weight approx. 1.6 kg
- blades: WK1-S, WK3, WK4R-S, WK4Z, WK5-S, WK6-M, WK24Z-S, WK24ZR-S, WK24, WK27S, WK28M, WK27RM, WK28RS
- adjustable cutting depth control arms: WK11AW, WK11BW5, WK11CW, WK11DW5, WK11EW, WK11FW
- accessories: WK-KEY, WK7, WK7L, WK8, WK9, WK11VEL, WK20, WK-GA
- training Package: users manual, WK12DVD Introduction & Training DVD
- sturdy plastic case

### ■ WKBTR15-BX BTB Bus, Truck & Rail Kit (15 blades)



For the bus, truck, rail and commercial vehicle industries, this toolkit contains blades specifically suited to adhesive bonded glass and bonded panel removal on today's transport fleets.

Kit contains:

- heavy duty air tool WK10HD, net weight approx. 1.6 kg
- blades: WK1-S, WK1X, WK2-S, WK4Z-S, WK4ZR-S, WK4-S, WK5-S, WK27S, WK27M, WK27L, WK28S, WK28M, WK28L, WK6-L, WK6-40
- adjustable cutting depth control arms: WK11BW5, WK11DW5, WK11EW
- accessories: WK7, WK7L, WK8DSM, WK9, WK9B, WK11VEL, WK20, WKGA
- training Package: users manual, WK12DVD Introduction & Training DVD
- sturdy plastic case

*quicklink to the  
product video*



### ■ WK10HD

#### BTB Heavy Duty Air Power Tool



- tool only (without blades and accessories), weight approx. 1.6 kg
- exclusive short and fast in-line stroke absorbs reciprocal cutting action of blades
- change blades in less than 10 seconds
- small, powerful and light weight
- cutting depth control system and nylon control head avoids scratching glass or painted panels
- low noise and vibration levels (HAV)
- fully adjustable speed, stroke and power
- motor speed without load max. 6,500 U/min
- air consumption only 140 l/min
- max. operating pressure 6.0 bar

*quicklink to the  
product video*



**BTB Blade**

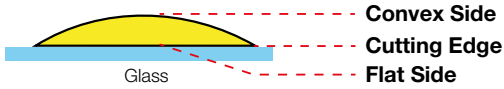

**BTB V-Blade**

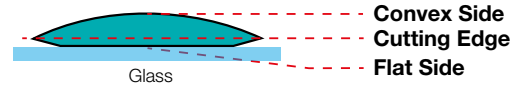

**BTB R-Blade**

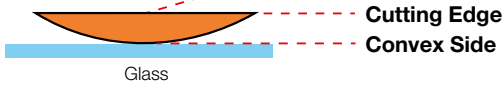

**BTB VR-Blade**



■ **WK1**



**BTB Long Blade, flat, 300 mm long**

■ **WK1-S**



**BTB Long Blade, flat, serrated, 300 mm long**

■ **WK1-X**



**BTB Extra Long Blade, flat, 370 mm long**

■ **WK1-ZX**



**BTB Extra Long Blade, cranked, 370 mm long**

■ **WK2**















**BTB Long Blade, flat, 240 mm long**

■ **WK2-S**



**BTB Long Blade, flat, serrated, 240 mm long**

	■ <b>WK3</b>	<b>BTB General Purpose Blade, bent, 200 mm long</b>
	■ <b>WK3-S</b>	<b>BTB General Purpose Blade, bent, serrated, 200 mm long</b>
	■ <b>WK4</b>	<b>BTB Blade, bent, flexible blade for curved glass, 190 mm long</b>
	■ <b>WK4-S</b>	<b>BTB Blade, bent, serrated, flexible blade for curved glass, 190 mm long</b>
	■ <b>WK4Z</b>	<b>BTB Blade, cranked, 140 mm long</b>
	■ <b>WK4Z-S</b>	<b>BTB Blade, cranked, serrated, 140 mm long</b>
	■ <b>WK5</b>	<b>BTB Blade, flat, 130 mm long</b>
	■ <b>WK5-S</b>	<b>BTB Serrated flat blade, 130 mm long</b>
	■ <b>WK24</b>	<b>BTB Long Blade, bent, flexible blade for curved glass, 240 mm long</b>
	■ <b>WK24-S</b>	<b>BTB Long Blade, bent, serrated, flexible blade for curved glass, 240 mm long</b>
	■ <b>WK24Z</b>	<b>BTB Blade, cranked, flexible blade for curved glass, 150 mm long</b>
	■ <b>WK24Z-S</b>	<b>BTB Blade, cranked, serrated, flexible blade for curved glass, 150 mm long</b>



■ **WK24ZV** BTB V-Blade, cranked, flexible blade for curved surfaces, 150 mm long



■ **WK24ZV-S** BTB V-Blade, cranked, serrated, flexible blade for curved surfaces, 150 mm long



■ **WK24ZVR-S** BTB Reverse V-Blade, cranked, serrated, flexible blade for curved glass, 150 mm long



■ **WK4R-S** BTB Reverse Blade, bent, serrated, flexible blade for curved glass, 190 mm long



■ **WK4ZR-S** BTB Reverse Blade, cranked, serrated, 140 mm long



■ **WK24R-S** BTB Reverse Blade, bent, serrated, flexible blade for curved glass, 240 mm long



■ **WK24ZR-S** BTB Reverse Blade, cranked, serrated, flexible blade for curved glass, 150 mm long



■ **WK4ZV-S** BTB V-Blade, cranked, serrated, for curved glass 140 mm long



■ **WK4ZVR-S** BTB VR-blade, cranked, serrated, sharpened on the rear side 140 mm long



■ **WK5Z-S** BTB Blade, cranked, serrated, 120 mm long



■ **WK5ZR-S** BTB Reverse Blade, cranked, serrated, 120 mm long



- **WK27S** BTB Left Hand Power Cold Knife Blade, 19 mm tip length
- **WK27M** BTB Left Hand Power Cold Knife Blade, 25 mm tip length
- **WK27L** BTB Left Hand Power Cold Knife Blade, 30 mm tip length
- **WK27XL** BTB Left Hand Power Cold Knife Blade, 45 mm tip length
- **WK27RM** BTB Left Hand Power Cold Knife Blade, reverse blade, 25 mm tip length

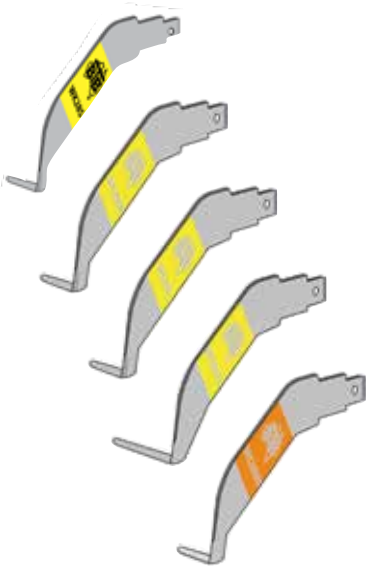

- **WK28S** BTB Right Hand Power Cold Knife Blade, 19 mm tip length
- **WK28M** BTB Right Hand Power Cold Knife Blade, 25 mm tip length
- **WK28L** BTB Right Hand Power Cold Knife Blade, 30 mm tip length
- **WK28XL** BTB Right Hand Power Cold Knife Blade, 45 mm tip length
- **WK28RM** BTB Right Hand Power Cold Knife Blade, reverse blade, 25 mm tip length



- **WK11PP** BTB Paint Protector for BTB Power Cold Knife Blades



■ **WK16LR** BTB Moulding Release Blade

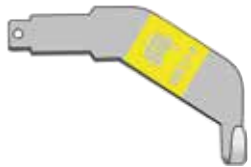

■ **WK17-4** BTB Backfill Removal Blade  
4 mm blade channel width

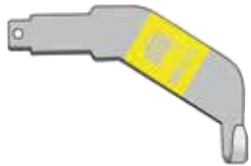

■ **WK17-6** BTB Backfill Removal Blade  
6 mm blade channel width



■ **WK18Z** BTB Spade Blade, cranked,  
140 mm long, wide spade shape



■ **WK18ZS** BTB Spade Blade, cranked, serrated,  
140 mm long, wide spade shape

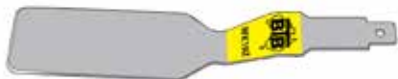

■ **WK19Z** BTB Spade Blade, cranked,  
180 mm long, wide spade shape



■ **WK19ZS** BTB Spade Blade, cranked, serrated,  
180 mm long, wide spade shape



■ **WK19L** BTB Spade Blade, straight,  
300 mm long, wide spade shape



■ **WK19L-S** BTB Spade Blade, straight, serrated,  
300 mm long, wide spade shape

■ **WK6-SET**

**BTB Pinchweld Scraper Set in 6 parts**

BTB Pinchweld Scraper Set, including the following components:



- 1 scraper blade 15 mm wide (WK6-S)
- 1 scraper blade 20 mm wide (WK6-M)
- 1 scraper blade 25 mm wide (WK6-L)
- 1 scraper blade 40 mm wide (WK6-40)
- 1 manual handle (WK7)
- 1 universal key (WK-KEY)

■ **WK6-N-SET**

**BTB Pinchweld Scraper Set in 6 parts**

The BTB Pinchweld Scraper Set with 6 parts allow a easy cut back from the polyurethane in curves and corners at the car body because of his tapered shaft.



Kit contains:

- 1 Scraper blade 15 mm wide (WK6-SN)
- 1 Scraper blade 20 mm wide (WK6-MN)
- 1 Scraper blade 25 mm wide (WK6-LN)
- 1 Scraper blade 40 mm wide (WK6-40N)
- 1 Manual handle (WK7)
- 1 Universal key (WK-KEY)

■ **WK6-MXN**

**BTB special winged pinchweld scraper blade, 20 mm wide 150 mm long**

Pinchweld Scraper Blade with curved end. Thereby the special shape reduces the risk of damaging the paint compared to standard scraper blades. The blades are suitable for our handle Part. No. WK7.





- **WK6-S** BTB Winged Pinchweld Scraper Blade, 15 mm wide
- **WK6-M** BTB Winged Pinchweld Scraper Blade, 20 mm wide
- **WK6-L** BTB Winged Pinchweld Scraper Blade, 25 mm wide
- **WK6-40** BTB Pinchweld Scraper Blade, 40 mm wide



- **WK6-SN** BTB Special Winged anti-scratch pinchweld Scraper Blade, tapered Shaft 15 mm wide
- **WK6-MN** BTB Special Winged anti-scratch pinchweld Scraper Blade, tapered Shaft 20 mm wide
- **WK6-LN** BTB Special Winged anti-scratch pinchweld Scraper Blade, tapered Shaft 25 mm wide
- **WK6-40N** BTB Pinchweld Scraper Blade, tapered Shaft 40 mm wide



■ **WK6-20N**

**BTB Pinchweld Scraper Blade with relieved shaft,  
20 mm wide**

■ **WK6-25N**

**BTB Pinchweld Scraper Blade with relieved shaft,  
25 mm wide**



■ **WK7**

**Manual Blade Handle for BTB blades**

■ **WK7L**

**Manual Blade Double Handle for BTB blades**

With the manual blade handle and the manual blade double handle you can use all BTB blades also manually.



■ **WK-KEY**

**BTB Universal Key**

Handy screwdriver for the blade clamping screw on the BTB tool.







■ CE-119

**Clip Remover, flat/narrow**

Clip Remover with flat and narrow nose for removing all kind of plastic clips. Ergonomically shaped, two-component ProGlass handle, shaft made of solid metal.

Total length: approx. 210 mm



■ CEG-1410

**Clip Remover flat/wide**

Clip Remover with flat and wide nose for removing all kind of plastic clips. Ergonomically shaped, two-component ProGlass handle, shaft made of solid metal.

Total Length: 220 mm



■ CE-657

**Clip remover, small**

A clip remover with a particular narrow and fine tip. With the pointedly approaching v-notch, it is especially suitable for very small clips at newer vehicle models.

Total Length: 195 mm



■ CEG-148

**Clip Remover „Pig Foot“, wide**

Simple Clip Remover for door coverings. For easy removal of door coverings without damaging the plastic clips.

Total Length: 230 mm

■ **CE-607**



**Clip-Remover, angled**

This clip remover is ideal for the removal of cowling clips in recessed holes and areas.

Total Length: 195 mm

■ **CE-175**



**Clip Remover flat/medium**

Clip Remover with flat and medium wide nose for removing all kind of plastic clips. Ergonomically shaped, very small two-component handle, shaft made of very solid metal.

Total Length: 175mm

■ **CE-590**



**Clip Removal Tool**

Very flat clip removal tool for all kind of clips with a reach of 10 cm even for clips far underneath the door lining. The other side has a reach of 5 cm and offers thereby a larger lever force.

Total Length: 230 mm

■ **CES-125**



**Clip-Remover Kit, in 2 parts**

The two clip removal tools in this kit have a fine tip and are very strong at the same time. They help you to remove all those small clips that were almost impossible to reuse because you were never able to remove them without damage.

Total Length: 155 mm



■ **CES-250**

**Clip Remover Kit, in 5 parts**

These five tools made of polished steel cover the whole range of door and lining clips. With this kit you can remove almost all clips fast, easily and without damage.



■ **CZ-540**

**Clip Removal Pliers to dismantle clips and linings**

Clip pliers for professional removal of plastic clips, no scratches or dents at the coachwork. Dismantling of door linings without damage.

Total Length: 240 mm



■ **CDZ-195**

**Clip Pliers**

Thanks to the specially designed jaws these pliers can also remove very flush installed clips and two-part clips.

Total Length: 195 mm



■ **CS-696**

**TrimClip Pliers to dismantle clips and linings**

Pliers with extra flat jaws with 3 different recesses. Each type and size of clips can be grabbed easily and safely.

Total Length: 210 mm

**■ CEK-180****Clip & Strip Remover, Total Length: 180 mm**

Very stable mounting lever made of plastic, one side offset once bent 90°.

**■ CEK-215****Clip & Strip Remover, Total Length: 215 mm**

Lever tool with one flat-angle wedge end and one clip lever end.

**■ MSL-265****Installation Lever flat/clip made of plastic, 265 mm long**

Long lever tool with one flat-angle wedge end and one clip lever end.

**■ MS-205****Installation Stick Pointed/Round plastic, 205 mm long**

This installation stick is the perfect tool for dismantling those damageable plastic covers from rear view mirrors and cameras.



■ **DHS-360**



**Dismantling Lever Set, made of plastic, in 5 parts**

Dismantling of clips, trims and linings with metal tools, often causes damages like scratches. Therefore this five parts tool is completely made of sturdy and loadable plastics. It is a must for each car glass workplace.

■ **DHS-500**



**Dismantling Lever Set made of composite plastic**

Dismantling of clips, trims and linings with metal tools, often causes damages like scratches. Therefore this five parts tool is completely made of sturdy flexible and loadable composite plastic. It is a must for each car glass workplace.

■ **DHH-5836**



**Removal lever & hook set**

This 22-piece lever and hook set combines all the relevant tools from our range for removing mirror and camera covers. This set is ideal for use anywhere on the vehicle where filigree work (covers, seals, strips, clips, etc.) needs to be carried out.

Kit contains:

- 1 x WZT-5836 Tool bag
- 1 x LHK-160 Trim Jack
- 1 x MHD-110 Double Mini Hook
- 1 x MHS-068 Hook and Pick Set
- 1 x PL-140 LED Penlight
- 1 x MHK-069 Ball-tipped Mini Hook Set
- 1 x MSL-265 Installation Lever flat/clip
- 1 x CEK-180 Clip & Strip Remover
- 1 x CEK-215 Clip & Strip Remover
- 2 x MS-205 Installation Stick Pointed/Round
- 2 x MS-180 Installation Stick Round/Flat
- 2 x MS-181 Installation Stick Round/Round



■ **LEC-SET1**

**Clip and Strip Remover Kit, in 4 parts**

4 straight clip and weather strip removers made of durable plastics.

Kit contains:

- 1 weather strip remover, flat (item no. LEC-175F)
- 1 straight clip remover, L-shaped (item no. LEC-175FL)
- 1 straight clip remover, V-shaped (item no. LEC-175FV)
- 1 straight clip remover, Z-shaped (item no. LEC-175FZ)



■ **LEC-175F**

**Weather Strip Remover, flat**

Total Length: 175 mm



■ **LEC-175FL**

**Straight Clip Remover, L-shaped**

Total Length: 175 mm



■ **LEC-175FV**

**Straight Clip Remover, V-shaped**

Total Length: 175 mm



■ **LEC-175FZ**

**Straight Clip Remover, Z-shaped**

Total Length: 175 mm



■ **LEC-SET2**

**Clip and Strip Remover Kit, in 3 parts**

3 bent clip and weather strip removers made of durable plastics.

Kit contains:

- 1 weather strip remover, bent (item no. LEC-175G)
- 1 bent clip remover, U-shaped (item no. LEC-175GU)
- 1 bent clip remover, V-shaped (item no. LEC-175GV)



■ **LEC-175G**

**Weather Strip Remover, bent**

Total Length: 175 mm



■ **LEC-175GU**

**Bent Clip Remover, U-shaped**

Total Length: 175 mm



■ **LEC-175GV**

**Bent Clip Remover, V-shaped**

Total Length: 175 mm

■ HBS-027

Trim & Clip Remover Kit in 27 parts,  
with blow moulded plastic case

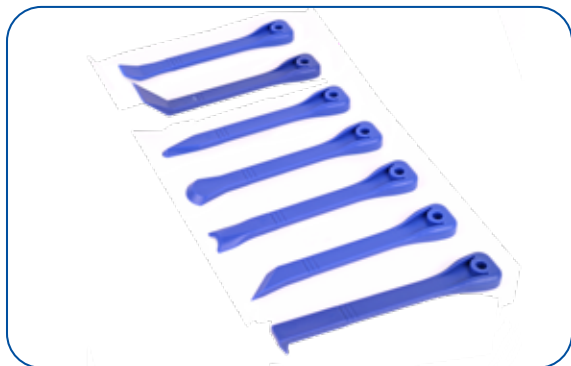

■ **MS-180**

**Installation Stick round/flat of ivory coloured plastic, 200 mm long**

The round end of the plastic installation stick is appropriate for working on rubber mouldings or render a fresh PU bead, the fl at scraper end is good to use for cleaning and removing excessive polyurethane. A tool with almost unlimited applications.



■ **MS-181**

**Installation Stick round/round of ivory coloured plastic, 200 mm long**

Plastic installation stick with two rounded ends for working on rubber mouldings or render a fresh PU bead. A tool with almost unlimited applications.



■ **IWH-692**

**Handle with installation stick round/round**

Handle with one installation stick with 2 round ends (like MS-181). The installation stick is fastened with a set screw.



■ **ISH-691**

**Handle for installation stick**

Hollowed out handle to hold an installation stick MS-180 or MS-181. The installation stick is fastened with a set screw.





■ **LHK-160**

**Trim Jack 160 mm long, 60 mm wide**

Sturdy trim jack made of plastic, for damage-free levering off chrome or aluminum strips.

■ **LH-230**



**Trim Jack, heavy duty model**

Heavy duty trim jack for removing tight metal trims and all other hardly to remove mouldings. Total length 230 mm.

■ **RFM-683**



**Trim Jack**

Mainly used to remove re-usable trims. The wide and flat form as well as the curvature enables to lift the trim without damaging. In addition it is perfect to lever simple rubber or plastic mouldings or trims with a metal core. Total length 205 mm.

■ **DLH-511**



**Moulding Release Tool with two hook ends**

Classical moulding release tool with two hook ends. Rubber spacers at the bottom avoid scratches on glass or varnishing.



■ **MHS-150**



**Hook and Pick Set with 2-component soft grip handle, in 4 parts**

These mini hooks are about 150 mm long (shaft length approx. 70 mm, handle 80 mm) and very helpful where standard size hook tools do not work. Thanks to the 2-component handles with black soft material, the tools sit very comfortably in the hand.

Total Length: 150 mm



■ **MHD-110**

**Double Mini Hook, set of 2 pieces**

These mini hooks have a long reach and can help you to adjust rubber mouldings where all other hook tools are simply too big. They are also great little helpers to pick up small pieces.

Total Length: 225 mm



■ **MHK-069**

**Ball-tipped Mini Hook Set, in 4 parts**

These ball-tipped mini hooks are very helpful where standard-sized ball-tipped hooks do not work. The ball diameter of each tool is 3.0 mm.

Total Length: 130 mm



■ **MHS-068**

**Hook and Pick Set, in 4 parts**

These mini hooks are only about 130 mm long. They are very helpful where 'normal' hook tools do not work.

Total Length: 130 mm



■ **BMR-1488**

**Belt Moulding Remover**

When removing a belt moulding it is important that you can save it. This tool slides down into the door opening and pulls out the moulding easily without any damage.

Total length: 190 mm



■ **CE-749**

**Special Tool for C-Clips**

For the removal of 'C'-shaped clips on window handles (e. g. Opel).



■ **GHK-560**

**Ball-Tipped Hook with extra long shaft**

This extremely long tool is great for cleaning glass run channels in vehicle doors. By moving the round tip up and down in the run channel it will push out any loose parts without damaging the rubber.

ball-Ø 6.0 mm, total length: 540 mm





■ **BND-2882**

**Blind Rivet Pliers with twistable head**

Some rivets are put into places that are almost inaccessible. This tool has a 360° twistable head that works in all directions. By that the nose can reach almost everywhere. Comes with four different nose pieces and a wrench to change them.



■ **BNZ-2685**

**Blind Rivet Pliers, standard**

Standard riveting tool with an extended nose length. Thanks to the long nose this tool lets you install rivets in vehicle doors with ease. Comes with four different nose pieces and a wrench to change them.



■ **BN-308**

**Blind Rivets, 3.0 x 8 mm, package at 50 pieces**

■ **BN-326**

**Blind Rivets, 3.2 x 6 mm, package at 50 pieces**

■ **BN-408**

**Blind Rivets, 4.0 x 8 mm, package at 50 pieces**

### ■ WAS-700

#### Universal Wiper Arm Puller Set



- No. 1 Alfa-Romeo, Audi, BMW, Citroen, Fiat, Ford, Honda, Jaguar, Mazda, MG-Rover, MB, Mitsubishi, Opel, Peugeot, Renault, Seat, Skoda, Volvo, VW, Mercedes, Chevrolet
- No. 2 Alfa-Romeo, Audi, BMW, Citroen, Fiat, Ford, Honda, Hyundai, Jaguar, Land Rover, MB, Opel, Peugeot, Renault, Saab, VW, Mercedes, Chevrolet
- No. 3 Alfa-Romeo, Audi, BMW, Fiat, Citroen, b Ford, Mazda, MB, Mitsubishi, Opel, Peugeot, Smart, Volvo, VW, Chevrolet
- No. 4 Citroen, Hyundai, MB, Opel, Mercedes, Chevrolet
- No. 5 Alfa-Romeo, Audi, BMW, Ford, Jaguar, Land Rover, Mazda, MB, Volvo, VW
- No. 6 Citroen, Ford, Peugeot

### ■ EWA-1702

#### Wiper Arm Puller Easy Lift

**shank width: 18 mm, working height: 32 mm**



This wiper arm puller is trouble-free applicable under casted air deflectors. It can also be used for nearly all other types of wipers. Made of hardened steel.

### ■ HWA-2636

#### Wiper Arm Puller "EasyLift II"

**shank width: 26 mm, working height: 38 mm**



The EasyLift II fits for Audi models from 2001. The wiper arm puller is designed for heavy use. It also offers a brass cap to protect the wiper arm thread against damage.



■ **WAF-1535**

**Wiper Arm Puller with flexible shank width  
15-35 mm, working height 40 mm**

Heavy wiper arm puller for almost all BMW series and Rolls Royce RR1 and RR2.

Also perfect for many other cars!



15 mm - 35 mm



■ **DWR-120**

**Wiper Arm Puller, Heavy Duty  
shank width: 16 mm, working height: 38 mm**

Extremely loadable wiper arm puller. For use on almost all passenger cars and many commercial vehicles. Especially recommended for the BMW E34 (5) and E32 (7) series, that have wipers with adjustable inclination.



■ **WAS-1630**

**Universal-Wiper Arm Puller  
shank width 16 mm, working height 30 mm**

The wiper arm puller impresses with its filigree, slim and robust design and can therefore be used universally. The large star grip makes it easy to pull off the wiper arms without additional tools! The puller is designed for very high loads. It also has a brass cap to protect the thread of the wiper arm shaft.



■ **WAB-150**

**Wiper Arm Puller BMW  
shank width: 23 mm, working height: 37 mm**

Heavy wiper arm puller for BMW from series E32/E34. This tool is designed very similar to the original BMW tool and has exactly the same function.



■ **WAS-4530**



**Wiper Arm Puller, universal**  
**shank width: 44 mm, working height: 35 mm**

A sturdy and heavy-duty puller for use on almost all passenger cars and many commercial vehicles, because of a large-scale adjustment to pull of the wipers. Easy Fixing per integrated spring mechanism.



■ **ZAW-090**



**Wiper Arm Puller, universal**  
**shank width 38 mm, working height 28 mm**

A sturdy tool for use on almost all passenger cars and many commercial vehicles, because of a large-scale adjustment to pull of the wipers.



■ **WAV-899**

**Wiper puller Volkswagen Group**  
**shank width: 63 mm, working height: 33 mm**

Suitable for most models from the Volkswagen group and many others. To protect the wiper arm bolt the large screw is hollow. So to use this tool the wiper arm nut must be loosened, but must remain on the bolt. By that the screw of the tool is holding up against the nut.



■ **WAN-3650**

**Wiper Arm Puller Audi Q7**  
**shank width: 36 mm, working height: 16 mm**

Compact and very robust wiper arm puller, especially designed for the wiper arm of the Audi Q7 and other models with similar wiper arm construction.



■ **UAZ-1950**

**Wiper Arm Puller, heavy-duty**  
**shank width: 18 mm, working height: 48 mm**

Real heavy universal puller for various jobs - also fits for many wiper arms.



■ **SWA-2316**

**Standard Wiper Arm Puller**  
**shank width: 16 mm, working height: 26 mm**

A universal wiper arm puller with clamping screw for easy handling (without extra tool). Suitable for many vehicles.



■ **WAZ-919**

**Wiper Arm Pliers**

Multi-purpose pliers to remove most standard wiper arms. Not suitable for heavy load.



■ **WDS-025**

**Washer nozzle protection for rear wiper**



The protective sleeve with M8 internal thread is screwed onto the wiper arm shaft of the rear wiper to protect the washer nozzle when pulling off the wiper arm.





■ **KZS-003-MW 3 Piece Plier Set**



Our 3-Piece Grip Pliers Kit provides you with solutions for a wide range of cutting and fastening application. To pull and loosening from metric screw (M8 till M10). Inductive hardened cutting blades for hard material. For easily pull wire and material through rough-in holes and other tight spaces. It also has an integrated fish tape puller. The hardened cutting edges giving you up to 2X more cuts. It also has a tapered nose with flush cutting blades, allowing you to cut all the way to the tip. With over-molded comfort grips, which will not peel after heavy use on the job site. All of our pliers are forged for strength and feature rust protection giving your tool long life.



■ **SPZ-160**

**Pointed Pliers With Wire Cutter**  
**170 mm long**

Pointed pliers make it easy to grip the wire end after it has been pierced through the adhesive bead. These pointed pliers do also have an integrated wire cutter.



■ **GPZ-225**

**Grip Pliers, 225 mm long**

- Straight grip pliers made of chromoly steel (CrMo)
- Holds round, profile and flat material securely
- With adjustment screw and release lever for one-hand operation
- High clamping pressure due to toggle lever action
- Holding capacity 0-30 mm



■ **RMP-416**

**Installation Pliers**  
**for rearview mirrors with bayonet clamp**

With these pliers you can easily remove and install all rearview mirrors with bayonet clamp (e. g. most VW and Audi models). No risk of damaging the windscreen or the mirror.



■ **RMP-416-1**

**Replacement Plastic Jaws for (1 pair) RMP-416**

(not shown)

■ **ISS-009-MW** Hex Key Set 9 pc



9 PC SAE L-Style inch Hex Key Set with Ball Ends features the easiest access keys. The pivoting holder with offset keys makes it quick and easy to grab the necessary size key. The keys withstand more torque and extend the life of the tool in the toughest jobsite conditions. The holder and keys have long-lasting, high-contrast markings for quick size identification. With a ball end, the keys are able to easily access fasteners even when at a difficult angle.

■ **MB-743** Rearview Mirror Screwdriver  
TORX T15 / TORX T20



■ **MB-744** Rearview Mirror Screwdriver  
hex driver 2.0 mm / hex driver 2.5 mm



■ **MBR-600** Rearview Mirror Screwdriver  
TORX T15 / Phillips PH1





### ■ SDM-421 Mini Screwdriver Set

Who doesn't know that! You can see the screw but no screwdriver can reach into the narrow space above the screw head. That's a job for the only 3.4 cm long mini screwdrivers! The set contains 2 Phillips screwdrivers (PH0, PH1) and 2 slotted screwdrivers (5 mm, 6 mm).



### ■ FSD-210-MW Fine Screwdriver Set at 6 pc PH/SL



Milwaukee® Precision Screwdrivers feature an All-Metal Core for up to 4X strength. Precision machined tips provide secure fitment and long life. The extended reach design and longer shanks deliver improved visibility and reach. 360-degree rotating back caps offer greater control, driving ability, and tuning. Additionally, color coded markings allow users to easily ID tool on the jobsite. Chrome plated shanks increase tool life by reducing corrosion and providing superior rust protection.

### ■ EPS-761 Magnetic Screwdriver, 300 mm long



Extra-long screwdriver 300 mm, magnetic, for all bits, includes one PH2 Bit











■ **BHS-058**

**1/4 Inch Bit Set with Bit Holder and Mini Ratchet**



Universal Bit-Set made of robust chrome-vanadium steel. The mini ratchet win over by a very low shape hereby it's perfect usable in small and narrow areas. Delivered in a sturdy plastic box (165 x 110 x 37 mm) with molded insert.

- |   |   |   |   |
|---|---|---|---|
|  | <b>PH 0 / 1 / 2 / 3</b>                   |  | <b>3 / 4 / 5,5 / 6,5</b>                                |
|  | <b>PZ 0 / 1 / 2 / 3</b>                   |  | <b>T 7 / 8 / 9 / 10 / 15 / 20 / 25 / 27 / 30 / 40</b>   |
|  | <b>6 / 8 / 10</b>                         |  | <b>STX 7 / 8 / 9 / 10 / 15 / 20 / 25 / 27 / 30 / 40</b> |
|  | <b>SW 2 / 2,5 / 3 / 4 / 5 / 6 / 7 / 8</b> |  | <b>IPR 10 / 15 / 20 / 25 / 27 / 30 / 40 / 45 / 50</b>   |
|  | <b>XZN M5 / M6 / M8</b>                   |   |   |

■ **SMB-135-MW Compact Ratcheting Multi-Bit Screwdriver 135 mm long**



Our 8-in-1 Compact Ratcheting Multi-Bit Screwdriver is the most versatile multi-bit screwdriver. This multi-bit driver features easy-access in-handle storage, which keeps bits organized and allows you to quickly change bit sizes and types. The durable, all-metal ratchet allows for higher torque and faster driving. This multi-bit also driver has a removable bit holder so the bit can go directly into the handle in the tightest of spaces. The removable bit holder has a 1/4" hex shank, making it power tool ready for maximum jobsite versatility. The chrome-plated bit holder provides rust protection and reduces wear from elements on the jobsite.

■ **SMB-260-MW Compact Ratcheting Multi-Bit Screwdriver 260 mm long**

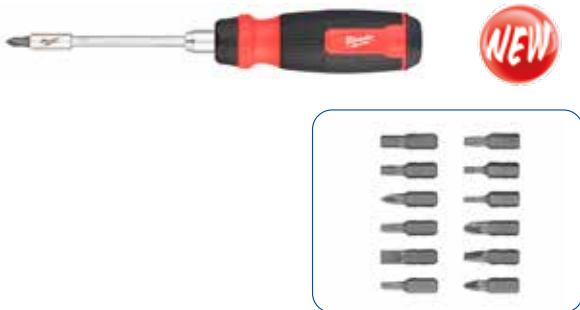

Our 14-in-1 Ratcheting Multi-Bit Screwdriver is the most versatile multi-bit screwdriver. This multi-bit driver features easy-access in-handle storage which keeps bits organized, allowing you to quickly change bit sizes and types. The durable, all-metal ratchet allows for higher torque and faster driving. The removable bit holder has a 1/4" hex shank, making it power tool ready for maximum jobsite versatility. The chrome-plated bit holder provides rust protection and reduces wear from elements on the jobsite.



### ■ STS-039

#### Socket Set 1/4 drive in 39 parts

Made of robust chrome-vanadium steel. Delivered in a sturdy plastic box (245 x 130 x 44 mm) with molded insert.

Kit contains:

- 1 ratchet wrench (72 teeth)
- 1 hand grip
- 1 short extension
- 1 large extension with toggle function
- 1 cardan joint
- 13 hexagon sockets (4/4,5/5/5,5/6/7/8/9/10/11/12/13/14)
- 4 cross-head bits (PH1/PH2/PZ1/PZ2)
- 2 slotted bits (5,5 / 7)
- 5 hexagon I-keys (1,2/1,5/2,0/2,5/3,0)
- 3 allen insert (4/5/6)
- 7 Torx (T8/T10/T15/T20/T25/T27/T30)

### ■ STS-032-MW 3/8 Metric Ratchet & Socket Set



Our MILWAUKEE® SAE 32 piece 3/8" drive Ratchet & Socket set is designed from the ground up, offering our users the Most Versatile Sockets that are Anti-Roll and Wrench-Ready. Its innovative FOUR FLAT™ Sides feature an anti-roll and wrench-ready design. The 90 tooth ratchet tool offers 4° of arc swing and a slim profile design, allowing you to work in tighter and more confined spaces, be it under the hood of a car or in the middle of a remodel. The ratchet and socket kit comes with a removable inner tray which is perfectly designed to be stored long-term in a steel storage chest. All of our sockets are stamped with metric measurements on the flat side for easy-to-read visibility. The set comes with accessories included so that our users can get every job done, both in the garage and on the jobsite.



■ **RSS-0819**

**Ratchet Wrench Set of 7 pieces**

- The professional ratchet mechanism has a gear with 72 teeth (5° returning angle) and allows you to work on narrow places.
- With their small ring end side these wrenches are the perfect alternative to classical ratchets and nuts.
- The wrenches conform to ANSI standard. However, opening very hard fixed screws with the gear-side could break the gear mechanism.
- The set includes the wrench sizes 8, 10, 12, 13, 14, 17 and 19 mm.
- Delivered on a wall-mountable plastic support.



■ **RGS-255-MW**

**Adjustable Wrench 255 mm**



Milwaukee Adjustable wrench has been designed from the ground up to offer maximum productivity to the professional user. The adjustable wrench features a proprietary adjustment screw for jaws that won't back off. The ergonomic handle form has been designed for maximum comfort and won't dig into the palms, and is chrome plated for rust protection and maximum tool life. The wrench's parallel jaw design won't slip or damage finish surfaces, and a tether-ready handle loop makes the Milwaukee Adjustable wrench perfect for the toughest of jobsites.



■ **MSP-2030**

**Nut Splitter Set**

If a nut is so damaged that you can not open it you should have a nut splitter available. The smaller one has an eye diameter of 20 mm, the bigger one of 30 mm. Total length is 117 resp. 150 mm.



■ **HLK-012** **Lift Support Clamp**

This clamp enables you to fix old pneumatic springs of bonnets or hatches. Open the bonnet up to the desired angle, attach the clamp - fix it - ready.



■ **THH-540** **Telescopic Bonnet Holder**  
made of aluminum, in 3 parts

■ **THH-540-G** **Set of Replacement Rubber Caps for THH-540**

Keeps the bonnet or hatch open at any desired angle. The telescopic bonnet holder is stepless adjustable from 54 to 120 cm.





■ **SSH-290**

**Window Holder Set**

Holds the side window while you are working on the window lifter so that you have both hands free. Very stable due to cast-in thread. Cable length 45 cm.



■ **LB-300**

**Power-Lifter inflatable bag 15 x 20 cm**

The PowerLifter facilitates detaching bonded glasses, regardless of the method used. You place the bag at an already detached point between the glass and the car body and inflate it. Lifting the glass, stretches the remaining PU bead, which can now be much easier detached. The bag is made of fibre-reinforced fabric, which is extremely tough and loadable. Only at about 150 kg the pressure-relief valve opens.





■ **AMM-880**

**Car installation magnet Ø 88 mm**

Very powerful fitting magnet with rubber coating for harmless working on metallic car body panels. For fitting from moulding, trim, emblem and foil.



■ **FIX-080-P**

**Moulding Clamp, red, package at 6 pieces**

■ **FIX-080**

**Moulding Clamp, red, single**

This version has a long slotted hole instead of the three single fixing holes. So it can be easier positioned. The PVC suction cup with a diameter of 80 mm holds on glass as well as on metal.

Versatile capabilities:

- retains freshly bonded mouldings, badges or mirror plates
- press on freshly bonded vehicle glazings (e. g. if the upper corners do not align properly)
- prevents freshly bonded vehicle glazings from sagging (fix the sucker to the window to hold it up against the roof)
- 8,0 kg Tensile strength 78,45 N
- 15,0 kg Shear strength 147,1 N









■ **FSK-300**

**ProGlass Pinchweld Scraper Kit in plastic case, with long scraper tool**

Kit contains:

- 1 pinchweld scraper, long (like item no. FSC-300)
- 10 blades 12 mm wide (item no. SC-313)
- 10 blades 16 mm wide (item no. SC-316)
- 10 blades 20 mm wide (item no. SC-320)
- 1 foam lined plastic case (240 x 215 x 45 mm)

■ **FSK-150**

**ProGlass Pinchweld Scraper Kit in plastic case, with short scraper tool (not shown)**

Same like FSK-300, but instead of a long scraper tool it comes with a short scraper tool (like item no. FSC-150).

The blades of this pinchweld scraper are sharp like razor blades. The practical clamping mechanism enables a very quick blade exchange without using any tools.

■ **FKM-145**

**Pinchweld Scraper Kit in plastic case, with short scraper tool and utility knife**

Useful set including a pinchweld scraper tool and a utility knife with numerous replacement blades.



Kit contains:

- 1 pinchweld scraper 150 mm long
- 5 blades 12 mm wide (like item no. SC-313)
- 5 blades 16 mm wide (like item no. SC-316)
- 5 blades 20 mm wide (like item no. SC-320)
- 5 blades angled, 16 mm wide (like item no. SCA-316)
- 1 utility knife
- 5 trapezoid blades (in dispenser, like item no. TK-10)
- 1 plastic case (240 x 160 x 50 mm)





■ **WRD-SKB**

**WRD Pinchweld Scraper Kit in plastic case, with long scraper tool & sharpening stones**

The WRD Pro Scraper system offers a safe standard in pinchweld preparation. The different high-grade razor blades designed specific for the task, with the convenient diamond sharpening solution you get a complete system.

■ **FSC-120**



**ProGlass Scraper with quick change system 120 mm long, with 5 blades 16 mm wide**

Aluminium pinchweld scraper without handle for fine cutting jobs. The practical clamping mechanism enables a very quick blade exchange without using any tools.

Includes 5 pieces of the 16 mm wide blade (like item no SC-316).

■ **FSC-150**



**ProGlass Pinchweld Scraper with quick blade exchange 150 mm long**

Pinchweld scraper with ergonomically shaped, non-skid handle and short shaft. The practical clamping mechanism enables a very quick blade exchange without using any tools.

Includes 5 pieces of the 16 mm wide blade (like item no SC-316).

■ **FSC-300**



**ProGlass Pinchweld Scraper with quick blade exchange 190 mm long**

Pinchweld scraper with ergonomically shaped, non-skid handle and long shaft. The practical clamping mechanism enables a very quick blade exchange without using any tools.

Includes 5 pieces of the 16 mm wide blade (like item no SC-316).



- SC-313
- SC-316
- SC-318
- SC-320
- SCA-316

**Scraper Blades 12 mm, package at 10 pieces**  
**Scraper Blades 16 mm, package at 10 pieces**  
**Scraper Blades 18 mm, package at 10 pieces**  
**Scraper Blades 20 mm, package at 10 pieces**  
**Scraper Blades angled, 16 mm wide, package at 10 pieces**

Our high-grade stainless steel scraper blades are optimized for the use with our tools FSC-120, FSC-150, FSC-300 and FKM-145. But they also fit with tools from other manufacturers.

For perfect results the grinded side of the blade faces to the body. By driving the tool in the correct angle you will get a constantly thin layer of remaining material. Damages to the car body can be really avoided.

**TIP:**

By pulling the loose end of the adhesive bead the blades will cut the material even easier.



- SCE-007
- SCE-012
- SCR-006
- SCR-012

**Parer Blade, 7 mm wide, max. cutting depth 9 mm**

**Parer Blade, 12 mm wide**

**Parer Blade, Ø 6 mm**

**Parer Blade, Ø 12 mm**

These parer blades are especially good for cleaning the pinchweld from excessively applied polyurethane in curves and corners. Thereby the special shape reduces the risk of damaging the paint compared to standard scraper blades. The blades are suitable for our scraper tools FSC-120, FSC-150, FSC-300 and FKM-145.



- **SRB-09**
- **SRB-12**
- **SRB-17**

**Pinchweld scraper blade, 9 mm wide**

**Pinchweld scraper blade, 12 mm wide**

**Pinchweld scraper blade, 17 mm wide**

The special shape significantly reduces the risk of damaging the paint in comparison to standard scraper blades.

The blades are suitable for our scraper tools FSC-120, FSC-150, FSC-300 and FMK-145.



- **SC-313E**
- **SC-316E**
- **SC-320E**

**Economy Scraper Blades 12 mm, package at 10 pieces**

**Economy Scraper Blades 16 mm, package at 10 pieces**

**Economy Scraper Blades 18 mm, package at 10 pieces**

The special shape significantly reduces the risk of damaging the paint in comparison to standard scraper blades.

The blades are suitable for our scraper tools FSC-120, FSC-150, FSC-300 and FMK-145.



- **WRD-SP130**

**Diamond Sharpening Pen 130 x 6,5 mm**



The special shape significantly reduces the risk of damaging the paint in comparison to standard scraper blades.

- **WRD-SS153**

**Diamond Sharpening Stone 153 x 51 x 8 mm**



Dual sided sharpening stone perfect usable for sharpening blades. Evenly distributed monocrystalline diamonds grains bonded to aluminum base.

■ **GS-380**



**Glass Scraper with plastic handle, for 40 mm wide blades**

Wide scraper with long handle for comfortable use. With its 40 mm wide, razor sharp blades this tool is dedicated to remove labels and to clean glasses from residues.

All metal parts are made of stainless steel. Delivered with 1 blade and a protective cover for safe storage when not in use.

■ **GS-120**



**Glass Scraper with retractable blade, for 40 mm wide blades**

Wide scraper with retractable blade for safe use and transportation. With its 40 mm wide, razor sharp blades this tool is dedicated to remove labels and to clean glasses from residues.

All metal parts are made of stainless steel or brass-plated. Includes 1 blade.

■ **RK-100A**



**Scraper blades 40 mm wide, package at 100 pieces**

Top quality industrial blades with a thickness of 0.009 (=0.23 mm) and a solid metal back. Each blade has a single paper wrapping in the box to prevent you from injuries.

■ **RK-100B**



**Economy Scraper blades 40 mm wide, package at 100 pieces**

Inexpensive industrial blades in thickness 0.009 (approx. 0.23 mm). Each blade individually packed in the box.

■ **RK-100HD**



**Heavy Duty Scraper blades 40 mm wide package of 100 pieces**

Heavy Duty industrial blades with a thickness of 0.012 (=0.30 mm) and a solid metal back. Each blade has a single paper wrapping in the box to prevent you from injuries.





■ **MS-6**

**Mini Scrapers, package of 6 pieces (sorted colours) for 40 mm wide blades**

The mini scrapers are simply practical and can be used for a million different things!

When not in use, the blade can be flipped so that the metal backed part faces outside. Like that the scraper can be carried in the pocket and is always on hand. Includes 1 blade per piece.



■ **RKK-10**

**Plastic Razor Blades, package at 10 pieces**

These plastic razor blades are good for removing stickers and labels from glass surfaces. As the blade is made of plastic it cannot scratch the glass like a metal blade could.



■ **FGS-140**

**Flat Glass Scraper with 1 blade, 89 mm wide**

■ **RK-8905**

**Razor blades for FGS-140, package of 5 pieces**

This extra wide glass scraper with its retractable 89 mm wide blade is perfectly suited for removing large labels and stickers or window films.





■ **FSL-213**

**ProGlass Pinchweld scraper with neoprene cover  
13 mm wide, exchangeable blade**

■ **FSL-216**

**ProGlass Pinchweld scraper with neoprene cover  
16 mm wide, exchangeable blade**

■ **FSL-219**

**ProGlass Pinchweld scraper with neoprene cover  
19 mm wide, exchangeable blade**

Standard pinchweld scraper tool (total length: 250 mm) with neoprene cover. The spring steel blade can be re-sharpened and, if necessary, be replaced.



■ **FSS-213**

**Pinchweld Scraper with aluminium handle  
13 mm wide, exchangeable blade**

■ **FSS-216**

**Pinchweld Scraper with aluminium handle  
16 mm wide, exchangeable blade**

■ **FSS-219**

**Pinchweld Scraper with aluminium handle  
19 mm wide, exchangeable blade**

Well-priced pinchweld scraper tool (total length: 240 mm). The spring steel blade can be re-sharpened and, if necessary, be replaced.



■ **SK-113**

**Scraper blade, 13 mm wide, 140 mm long**

■ **SK-116**

**Scraper blade, 16 mm wide, 140 mm long**

■ **SK-119**

**Scraper blade, 19 mm wide, 140 mm long**

Spring steel pinchweld scraper blades suitable for all pinchweld scrapers of this page and many standard pull knives.

**NOTE:** The 13 and 16 mm wide blades do not fit with quick release pull knives.



■ **FSK-003**

**Pinchweld Scraper Set, in 3 parts**

Set with three different pinchweld scrapers. Fixed blades made of polished spring steel.

- 1 blade approx. 100 mm long, 16 mm wide
- 1 blade approx. 50 mm long, 20 mm wide
- 1 blade approx. 50 mm long, 13 mm wide



■ **SKS-003**

**Scraper Set, in 3 parts**

Set with three different scrapers. Fixed blades made of polished spring steel. Metal cap at the rear end of the handle.

- 1 blade approx. 100 mm long, 50 mm wide
- 1 blade approx. 100 mm long, 32 mm wide
- 1 blade approx. 100 mm long, 32 mm wide, bent



■ **UCH-319**

**U-Groove Parer Knife with pull handle**

With the round shape of its blades this knife is able to clean excessive polyurethane from the pinchweld where a normal pinchweld scraper will not work. Two different wide blades let you cut narrow or wide grooves.

Includes one small and one large blade.



■ **UCC-320**

**U-Groove Parer Knife without pull handle**

Includes one small and one large blade.



■ **UCL-322**

**Wide Parer Blade, for UCH-319 and UCC-320**

width of cut: approx. 9 mm depth of cut: approx. 18 mm



■ **UCS-321**

**Small Parer Blade, for UCH-319 and UCC-320**

width of cut: approx. 7 mm depth of cut: approx. 18 mm

■ **BK-315**



**Banana Knife with serrated blade  
total length 320 mm**

The blade is serrated on the inside and sharpened on the outside. With its bent shape it is ideal to cut a polyurethane bonding where pull knives or cut-out tools will not work (e. g. the lower corners of a windscreen that are often covered by the wings). Thanks to its long narrow blade it has an extremely good reach and outmatches a standard long knife.

■ **BK-230**



**Replacement Blade for Banana Knife BK-315**

■ **LM-460**

■ **LM-610**



**ProGlass Long Knife 460 mm long**

**ProGlass Long Knife 610 mm long**

Rugged long knife made of aluminium with a non-skid neoprene covered handle. Integrated spare blade compartment. Includes 2 trapezoid blades.



### ■ CMS-160-MW Cutter knife standard



Compact Folding Utility Knife features a press and flip mechanism for easy, one-handed opening. The MILWAUKEE® utility knife allows you to make quick, tool-free blade changes for maximum jobsite efficiency with a metal extension over the button to prevent accidental blade removal. The press and flip-open drywall/utility knife's compact size allows for easy storage while a durable wire belt clip reduces pocket tearing. The small utility knife has a blade holder designed for scoring. The compact folding knife also includes a lanyard hole for convenient tethering.

### ■ CMM-175-MW Cutter knife with magazine



Folding Utility Knife with Blade Storage features a press and flip mechanism for easy, one-handed opening. This press-and-flip-open utility knife offers you tool-free blade changes for fast blade swaps with a metal extension over the button to prevent accidental blade removal. The FASTBACK™ Folding Utility Knife has onboard blade storage, allowing you to store 5 extra blades, and has a wire stripper for increased productivity. The MILWAUKEE® utility knife has a metal body that provides durability and an integrated gut hook for versatility. The utility knife has a durable wire belt clip that reduces pocket tearing and a blade holder designed for scoring.

### ■ CMB-165-MW Cutter knife standard 6-in-1



6-in-1 Folding Utility Knife features a press and flip mechanism providing you with an easy, one-handed opening. The 6-in-1 knife has a wire stripper, folding screwdriver, and a fold-out 1/4" bit holder. The bit holder includes a reversible Phillips #2 and slotted 1/4" bit. For added functionality, it also has extra blade storage for one blade and a built-in bottle opener. Tool-free blade change allows you to quickly and easily insert a new blade. This multifunction utility knife has a durable wire belt clip to reduce pocket tearing with a blade holder designed for scoring. The MILWAUKEE® 6-in-1 Folding Utility Knife has a metal extension that prevents accidental blade removal and a lanyard hole for convenient tethering.



■ UMS-437

**Utility Knife AMERICAN-LINE**

This light-weight and handy utility knife with black painted aluminium handle has a fully retractable blade, a multi-step blade length adjustment and offers a spare blade compartment inside the handle. The solid blade holder inside is also made of metal so the blade will not slip out under heavy use. Includes 1 trapezoid blade.

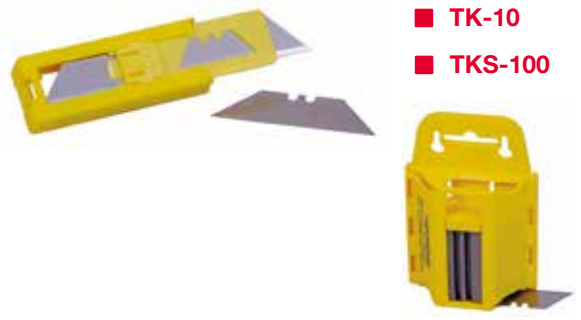

■ TK-10

**Trapezoid Blades, dispenser at 10 pieces**

■ TKS-100

**Trapezoid Blades, dispenser at 100 pieces**

The dispenser lets you easily withdraw new blades individually. Used blades are inserted at the top of the dispenser and so they are safely put away.



■ XUB-05

**Trapezoid Blades, extra long, package at 10 pieces**

The cutting length of these blades is 95 mm while standard trapezoid blades are only 60 mm long. This blade increases the range by 60 mm!

**NOTE:** When using a retractable blade knife these extra long blades will not be retracted completely.



■ HK-5

**Hooked Blades, package at 5 pieces**

The hooked blades are perfect for cutting off rubber seals from installed glasses without damaging the car body because only the non-cutting part on the outside is facing to the body.



**■ SVR-2****Olfa® Silver Knife for 9 mm blades with 3 snap-off blades**

Knife and blades are made of stainless steel - therefore this is the ideal tool for the installation of window films.

**■ OL-40****Olfa® Knife for 9 mm wide blades with 1 snap-off blade**

A small and handy knife with 9 mm wide snap-off blades for all fine jobs.

**■ MESSER-C****Cutter Knife 9 mm with ProGlass-Logo Print with 1 snap-off blade**

A small and handy knife with 9 mm wide snap-off blades for all fine jobs with ProGlass logo and imprint:

[www.proglass.de](http://www.proglass.de)

**■ NTC-400****NT Cutter Knife for 9 mm wide blades with 1 snap-off blade**

Very handy and narrow cutter knife, which impresses with its length of 185 mm. The quick retraction mechanism ensures fast, stress-free and safe work.



■ **AB-10**

Olfa® Snap-Off Blades 9 mm package at 10 pieces



■ **ASBB-10**

Olfa® Snap-Off Blades extra sharp, 9 mm wide, package at 10 pieces



■ **ABB-50**

Olfa® Snap-Off Blades extra sharp, 9 mm wide package at 50 pieces



■ **AB-10S**

Olfa® Snap-Off Stainless Steel Blades 9 mm package at 10 pieces



■ **AB-50S**

Olfa® Snap-Off Blades (stainless steel), 9 mm wide, package at 50 pieces



■ **SAB-10**

Olfa® Graphic Snap-Off Blades, 30°, 9 mm wide, package at 10 pieces

■ **MT-1**

Olfa® Knife for 12.5 mm wide blades with 1 snap-off blade



■ **MTB-10B**

Olfa® Snap-Off Blades, 12.5 mm wide, package at 10 pieces



■ **FWB-10**

Olfa® Snap-Off Blades extra sharp, 12.5 mm wide, package at 10 pieces



■ **L-2**

**Olfa® Knife for 18 mm wide blades  
with 1 snap-off blade**

Cutter knife with knurled screw to fix the blade to the desired length



■ **XL-2**

**Olfa® Long Knife for 18 mm wide blades  
with 1 snap-off blade**

Cutter knife with knurled screw to fix the blade to the desired length



■ **CMK-170**

**Cutter knife with automatic blade magazine**

Cutter knife for 18 mm blades with integrated and automatic blade magazine for a maximum of 6 x supplied blades.

- 

■ **ABK-10**



Snap-Off Blades, 18 mm wide,  
package at 10 pieces
- 

■ **LB-10**

Olfa® Snap-Off Blades 18 mm,  
package at 10 pieces
- 

■ **LB-50B**

Olfa® Snap-Off Blades, 18 mm wide,  
package at 50 pieces

- 

■ **LBB-10**

Olfa® Snap-Off Blades extra sharp, 18 mm wide  
package at 10 pieces
- 

■ **LBB-50**

Olfa® Snap-Off Blades extra sharp, 18 mm wide  
package at 50 pieces
- 

■ **LSOL-10**

Olfa® Solid Blades 18 mm, not segmented,  
package at 10 pieces
- 

■ **LWB-3B**

Olfa® blade, 18 mm wide, not segmented, with serrated edge,  
package at 3 pieces





■ **H-1**

**Olfa® Extra Heavy Duty Cutter 25 mm  
with 1 snap-off blade**

Cutter knife with knurled screw to fix the blade to the desired length



■ **HB-5**

**Olfa® Snap-Off Blades 25 mm  
package at 5 pieces**



■ **HBB-5B**

**Olfa® Snap-Off Blades extra sharp, 25 mm wide  
package at 5 pieces**



■ **HOK-1**

**Olfa® Hook Cutter**



■ **HOB-1**

**Olfa® Hooked Blade, single**

■ **CK-2**

**Olfa® Knife with 20 mm blade**

Solid cutting knife with 1 blade off stainless steel. Blade with a length of cut over 55 mm, beveled up 45°, grindable, and a locking screw for latching.



■ **CKB-2**

**Olfa® Blades 20 mm wide**

20 mm stainless steel blade with a cutting length of 55 mm bevelled to 45°, resharpenable and stainless.



■ **SCR-L**

**OLFA® Scraper, large model, 60 mm Stainless Steel blade**

The stainless-steel blade offers better protection against rusting and longer use. An ergonomic acetone-resistant handle makes cleanup easy. The blade integrated into the handle and is not replaceable, but any time grindable.



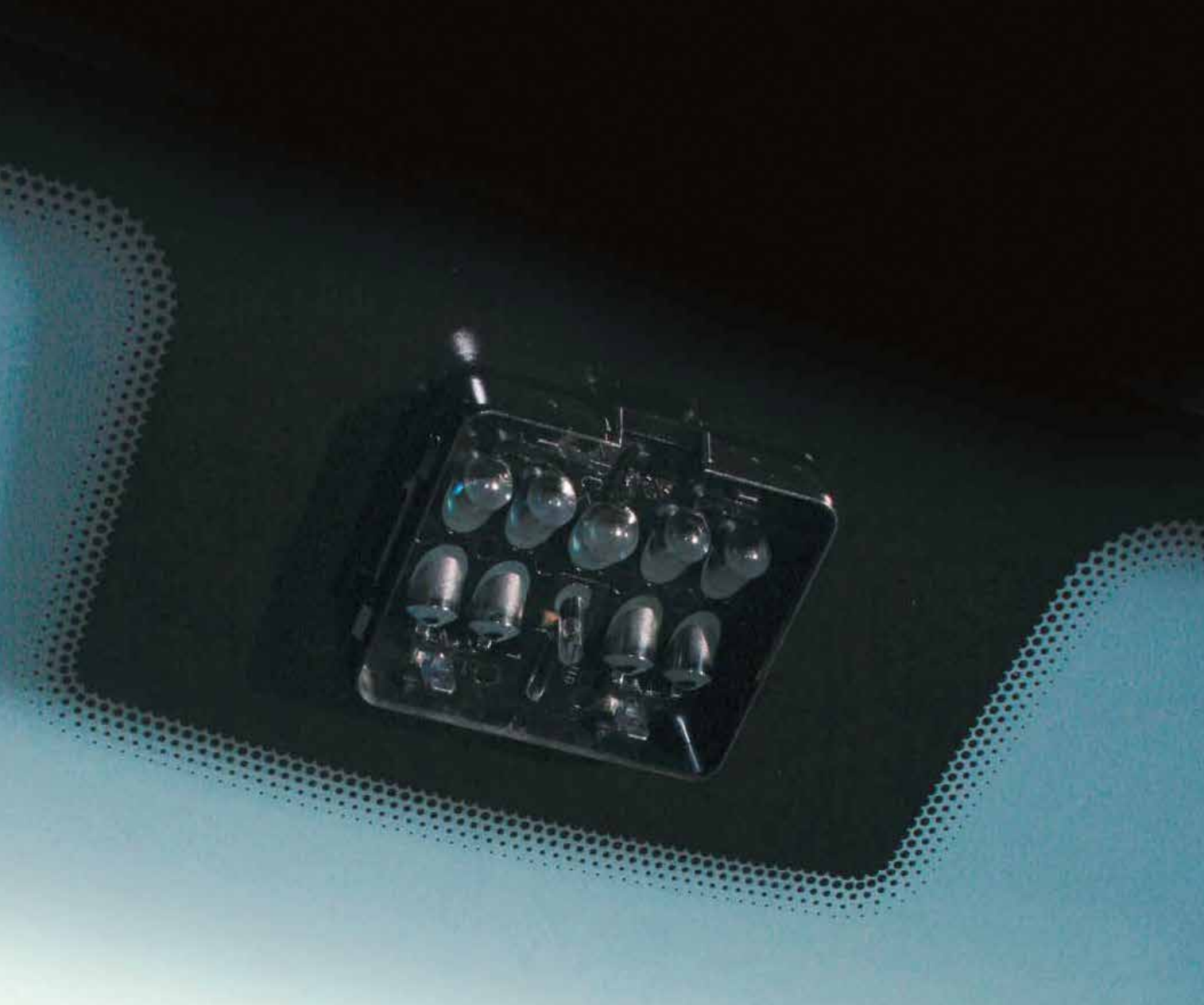

## Rain, Light and Air Con Sensors in best quality from OE manufacturers

The basic version of more and more vehicles is already equipped with a rain or light sensor. Since 2003 BMW additionally uses an anti-fogging sensor which controls the air conditioning system.

Indeed it is possible in most cases to transfer the optical unit from the old to the new windscreen, but therefore the adhesive pad - means the crystal clear bond between optical unit and windscreen - has to be renewed. Depending on the model, this can be very time consuming. It is faster

and easier to use a new optical unit (all our optical units are already equipped with an adhesive pad).

To ensure a faultless function of the extensive controlling electronics you should solely use genuine parts. Reproductions which can be found on the market can eventually lead to installation problems or even malfunction.



■ **SOR-199**

### Rain Sensor for Alfa Romeo, BMW, Mercedes, Rover

Vehicle Type	Eurocode	YOC
Alfa 147	2037	2001 -
Alfa 166	2036	1998 -
BMW E38	2433	1994 - 2001
BMW E39	2434	12/1995 - 09/2001
BMW E46 Lim./Coupé	2436	1998 - 09/2001
BMW E53 X5	2439	04/2000 - 09/2001
Mercedes W129 SL	5331	1989 - 2001
Mercedes W140 S-Class	5333	1991 - 1998
Mercedes W202 C-Class	5334	03/1993 - 05/2000
Mercedes W203 C-Class	5351	05/2000 - 04/2003
Mercedes W203 Sport Coupé	5352	03/2001 - 06/2003
Mercedes W208 CLK	5341	1997 - 2002
Mercedes W210 E-Class	5337	1995 - 2002
Mercedes W215 CL	5345	03/1999 -
Mercedes W220 S-Class	5344	1998 - 08/2002
Mercedes W230 SL	5346	2001 -
Rover 75	7035	06/1999 - 01/2004



### ■ SOL-192D

#### Light and Rain Sensor for Fiat, Mercedes, Smart, VW

Vehicle Type	Eurocode	YOC
Fiat Ducato III	3750	07/2006 -
Mercedes BM906 Sprinter	5439	06/2006 -
Mercedes W169 A-Class	5358	2004 -
Mercedes W171 SLK	5356	2004 - 2010
Mercedes W245 B-Class	5358	2005 -
Smart ForTwo	5368	2007 -
Smart ForFour	5359	2004 -
Smart Roadster	5355	2003 -
VW Crafter	8590	04/2006 -



### ■ SOL-189

#### Light and Rain Sensor for Citroen, Mercedes, Peugeot

Vehicle Type	Eurocode	YOC
Citroen C-Crosser	2738	2007 -
Mercedes W204 C-Class	5364	2007 -
Mercedes W212 E-Class	5371	2009 -
Mercedes W207 E-Class Coupé	5370	2009 -
Mercedes GLK	5369	2008 -
Peugeot 4007	6555	2007 -



### ■ SOL-193A

#### Light and Rain Sensor for BMW and Mazda

Vehicle Type	Eurocode	YOC
BMW E39 5-er Limousine	2434	09/2001 - 06/2003
BMW E39/2 5-er Touring	2434	09/2000 - 02/2004
BMW E46/2 3-er Coupé	2437	01/1999 - 05/2006
BMW E46/2C 3-er Cabrio	2437	12/1999 - 11/2006
BMW E46/3 3-er Touring	2436	06/1999 - 08/2005
BMW E46/4 3-er Limousine	2436	01/1998 - 03/2005
BMW E53 X5 - SUV	2439	09/2001 - 11/2006
BMW E65 7-er	2443	10/2001 - 03/2003
BMW E83 X3 - SUV	2449	09/2003 - 08/2007
Mazda 2 (J37L)	5173	2007 -
Mazda 3 (J48C)	5166	2003 -
Mazda 6 (J50C)	5164	2005 -



### ■ SOL-193B

#### Light and Rain Sensor for BMW

Vehicle Type	Eurocode	YOC
BMW E46 Compact	2442	06/2001 - 08/2001
BMW E60 5-er Limousine	2445	03/2003 -
BMW E61 5-er Touring	2445	03/2004 -
BMW E63 6-er Coupé	2446	09/2003 -
BMW E64 6-er Cabrio	2446	12/2003 -
BMW E87 1-er Limousine	2448	06/2004 -
BMW E90 3-er Limousine	2447	12/2004 -
BMW E91 3-er Touring	2447	06/2005 -
BMW E92 3-er Coupé	2454	06/2006 -
BMW E93 3-er Cabrio	2450	12/2006 -
BMW Z85 Z4 Roadster	2444	02/2003 -
BMW Z85 Z4 Coupé	2453	03/2006 -



■ **SKA-502**

**Anti-Fogging Sensor for BMW**

Vehicle Type	Eurocode	YOC
BMW E60/E61 5-er	2445	2003 -
BMW E63/E64 6-er	2446	2004 -
BMW E65 7-er	2443	2003 -
BMW E87 1-er	2448	2004 -
BMW E90 3-er	2447	2005 -



■ **SKA-502M**

**Fit-Up Aid for BMW Anti-Fogging Sensor**

Vehicle Type	Eurocode	YOC
BMW E60 5-er	2445	2003 -
BMW E63/64 6-er	2446	2004 -
BMW E65 7-er	2443	2003 -
BMW E87 1-er	2448	2004 -
BMW E90 3-er	2447	2005 -

## Gel Pads for LRS (light and rain sensors)

While in the nineties most sensors had a separate optical unit that was bonded to the glass, the trend nowadays goes to integrated models. These sensors combine the electronic and optical unit in one compact box. When a windscreen is replaced the whole box is taken over to the new glass. These sensors are no longer bonded to the glass, but the optical unit is only joint on to it with a gel pad which can be replaced easily in case of a windscreen exchange.

### How to proceed:

Take off the sensor box from the old windscreen. To do this it is either sufficient to dismount the rearview mirror or to release the retaining bracket. Afterwards the sensor box can be removed from the glass without effort (Pay attention to sensors with opaque silicone pads! These sensors can stick to the glass very tightly and it is very likely to damage the silicone pad. To remove such a sensor we recommend to heat the glass from the outside with a hot air gun - this will help to remove the silicone pad together with the sensors more easily and without damage).

When removing the sensor box in most cases the gel pad will be destroyed. This is why the vehicle manufacturers have specified that the sensor pad must be renewed every time the sensor has been dismounted (this is especially important for crystal clear gel pads). The gel residue can be removed easily by rubbing them off manually. If required you can use a mild cleaner with high alcohol content (e. g. our applicator KPA-250). Please let evaporate thoroughly! Then place the right gel pad on the clean sensor surface and mount the sensor box to the new windscreen.

**ATTENTION:** The applicator KPA-250 must not be used with our gel pads. The high alcohol content would affect the material. If you need to use a liquid applicator you can use clear water or a liquid glass cleaner with a low alcohol content.



■ **GPL-154**

**Gel Pads for rain/photosensor Mazda, Lexus, Subaru, Toyota, Package at 5 pieces**

■ **GPL-154-1**

**Gel Pads for rain/photosensor Mazda, Lexus, Subaru, Toyota, Package at 1 piece**

Dimensions: 26 x 34 x 2.0 mm



■ **GPL-156**

**Gel Pads for rain/photosensor, Ford, Jaguar, Land Rover, Porsche, Seat, Skoda, VW, Package at 5 pieces**

■ **GPL-156-1**

**Gel Pads for rain/photosensor, Ford, Jaguar, Land Rover, Porsche, Seat, Skoda, VW, Package at 1 piece**

Dimensions: 50 x 37 x 3 mm



Detailed vehicle type allocation table on our website at [www.proglass.de](http://www.proglass.de) or upon request!



■ **GPL-158**

**Gel Pads for rain/photosensor, Citroen, DS4, DS5, Infiniti, Jaguar, Land Rover, Mercedes, Peugeot, Package at 5 pieces**

■ **GPL-158-1**

**Gel Pads for rain/photosensor, Citroen, DS4, DS5, Infiniti, Jaguar, Land Rover, Mercedes, Peugeot, Package at 1 piece**



Dimensions: Ø 41 x 32 x 41 x 3 mm

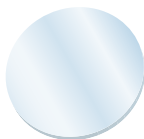

■ **GPL-166**

**Gel Pads for rain/photosensor Seat, Skoda, VW, Package at 5 pieces**

■ **GPL-166-1**

**Gel Pads for rain/photosensor Seat, Skoda, VW, Package at 1 piece**

Dimensions: Ø 32 x 1.5 mm

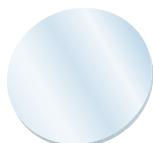

■ **GPL-168**

**Gel Pads for rain/photosensor Audi, BMW, Buick, Cadillac, Chevrolet, Ford, Opel, Package at 5 pieces**

■ **GPL-168-1**

**Gel Pads for rain/photosensor Audi, BMW, Buick, Cadillac, Chevrolet, Ford, Opel, Package at 1 piece**

Dimensions: Ø 31 x 1.5 mm

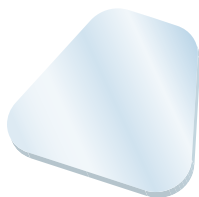

■ **GPL-170**

**Camera gel pad for Audi, Citroën, Mercedes, Porsche, Package at 5 pieces**

■ **GPL-170-1**

**Camera gel pad for Audi, Citroën, Mercedes, Porsche, Package at 1 piece**



Dimensions: 46 x 41 x 3 mm



■ **GPL-190**

**Gel Pads for rain/photosensor Audi, Alfa, Fiat, Ford, Volvo, Toyota, Opel, Seat, Package at 5 pieces**

■ **GPL-190-1**

**Gel Pads for rain/photosensor Audi, Alfa, Fiat, Ford, Volvo, Toyota, Opel, Seat, Package at 1 piece**

Dimensions: 27 x 32.5 x 1.5 mm

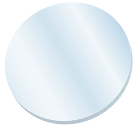

■ **GPL-191**

**Gel Pads for rain/photosensor Alfa, Citroen, Fiat, Mercedes, Porsche, Skoda, Toyota, VW, Package at 5 pieces**

■ **GPL-191-1**

**Gel Pads for rain/photosensor Alfa, Citroen, Fiat, Mercedes, Porsche, Skoda, Toyota, VW, Package at 1 piece**

Dimensions: Ø 27 x 1.5 mm

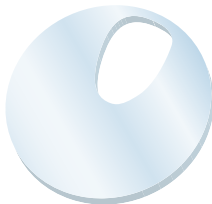

■ **GPL-192**

**Gel Pads for rain/photosensor Fiat, Ford, Mercedes, Nissan, Renault, Setra, Package at 5 pieces**

■ **GPL-192-1**

**Gel Pads for rain/photosensor Fiat, Ford, Mercedes, Nissan, Renault, Setra, Package at 1 piece**

Dimensions: Ø 44 x 2.5 mm

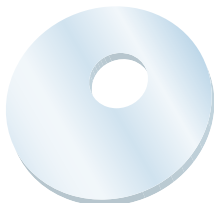

■ **GPL-192C**

**Gel Pads for rain/photosensor BMW, Nissan, Renault, Smart, Package at 5 pieces**

■ **GPL-192C-1**

**Gel Pads for rain/photosensor BMW, Nissan, Renault, Smart, Package at 1 piece**

Dimensions: Ø 43 x 2.5 mm

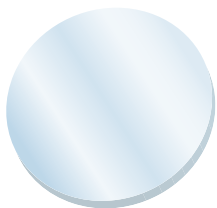

■ **GPL-194**

**Gel Pads for rain/photosensor MAN, Mercedes, Neoplan, Scania, VDL Package at 5 pieces**

■ **GPL-194-1**

**Gel Pads for rain/photosensor MAN, Mercedes, Neoplan, Scania, VDL Package at 1 piece**

Dimensions: Ø 44 x 3 mm

■ **GPL-SET**



**ProGlass Sensor Box 60-pcs.**

The set contains the most common sensor gel pads as well as 2K sensor gel in the syringe, sorted in a practical plastic box with article allocation.

Included in the set:

- 5 x GPL-154-1
- 5 x GPL-156-1
- 5 x GPL-158-1
- 5 x GPL-166-1
- 5 x GPL-168-1
- 5 x GPL-170-1
- 5 x GPL-190-1
- 5 x GPL-191-1
- 5 x GPL-192-1
- 5 x GPL-192C-1
- 5 x GPL-194-1
- 5 x PSG-004Q

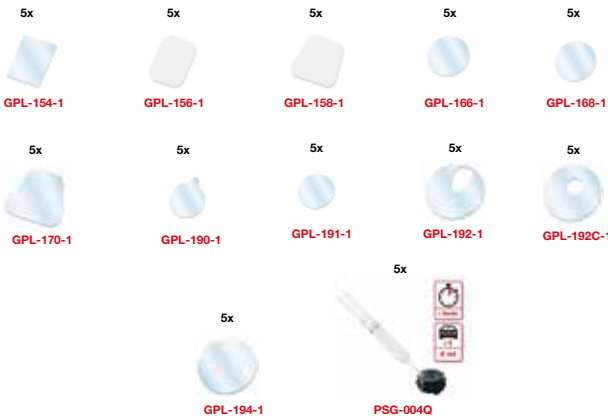



■ **PSG-001**

**ProGlass Sensor Gel 4 ml**

■ **PSG-001-25**

**ProGlass Sensor-Gel Package at 25 x pieces**

Sensor gel for the regeneration of the gel pad of all light and rain sensors with crystal clear silicone pad.

Two-component special silicone gel for one complete refill of a big sensor, like e. g. on Renault Espace, MB Sprinter or BMW 5 series (our item no. SOL-192...).

If the repair gel is not used completely at once, for example when filling a smaller sensor, immediately remove the mixing nozzle and seal the syringe with the original cap. Additional mixing nozzles are available under item no. PSG-MD10/K.

■ **PSG-MD10**

**Mixing Nozzle for Sensor Gel, package at 10 pieces, 59 mm long**

■ **PSG-MD10-K**

**Mixing Nozzle for Sensor Gel package at 10 pieces, 50 mm long**





■ **PSG-004Q**

**ProGlass Quick Sensor-Gel 4 ml**

■ **PSG-004Q-25**

**ProGlass Quick Sensor-Gel 4 ml, package at 25 pieces**



Quick Sensor gel for the regeneration of the gel pad (in only 4 minute) of all light and rain sensors with crystal clear silicone pad. Two-component special silicone gel for three complete refill of three big sensor, like e. g. on Renault Espace, MB Sprinter or BMW 5 series (our item no. SOL-192...).

If the repair gel is not used completely at once, immediately remove the mixing nozzle and seal the syringe with the original cap. Additional mixing nozzles are available under item no. PSG-MD10/K.



■ **PSG-012Q**

**ProGlass Quick Sensor-Gel 12 ml**

Quick Sensor gel for the regeneration of the gel pad (in only 4 minute) of all light and rain sensors with crystal clear silicone pad. Two-component special silicone gel for three complete refill of three big sensor, like e. g. on Renault Espace, MB Sprinter or BMW 5 series (our item no. SOL-192...).

If the repair gel is not used completely at once, immediately remove the mixing nozzle and seal the syringe with the original cap. Additional mixing nozzles are available under item no. PSG-MD10/K.

■ **RSL-330**

**Rain Sensor Level**

Easily adjustable level for perfect alignment of the sensors to be filled. By leveling the sensor body, a 100% even filling is achieved.



## Replacement Adhesive Pads for rain and light sensors

For more and more vehicles a rain or light sensor is already part of the standard equipment. When exchanging a windscreen, the optical unit of the sensor is also often being replaced, though it is not necessary. Our special adhesive pads, made of entirely transparent, self-adhesive material, enable you to reuse the optical unit.

How to proceed:

First remove the optical unit carefully from the glass with an installation stick or a sensor removal tool. As most of the optical units are made of plastic, they must not get in contact with solvent based cleaners. It is best to peel off the remaining glue with the fingers. For the final cleaning, use a cleaner that

evaporates without residue and does not corrode the plastic, e.g. our primer/cleaner **HRS-100**. Now first stick on the adhesive pad to the optical unit and then the whole part to the windscreen. For bubble-free, perfect results use our applicator **KPA-250**.

By the way, our adhesive pads are also suitable for many sensors with a gel pad. On our website you can find an instruction how to proceed in that case. Upon request our sales staff will also be happy to send it to you.



### Light/Rain Sensor Adhesive Pad for Toyota Dimensions: 25 x 34 x 2.0 mm

- **KPL-154** Package at 5 pieces
- **KPL-154-1** Package at 1 piece

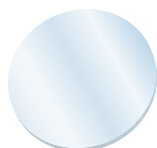

### Light/Rain Sensor Adhesive Pad for Seat, VW Dimensions: Ø 32 x 1.5 mm

- **KPL-166** Package at 5 pieces
- **KPL-166-1** Package at 1 piece

Detailed vehicle type allocation table on our website at [www.proglass.de](http://www.proglass.de) or upon request!

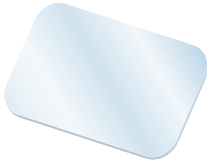

**Light/Rain Sensor Adhesive Pad for Honda, Kia, Opel, Saab**  
**Dimensions: 40 x 27 x 1.0 mm**

- **KPL-185** Package at 5 pieces
- **KPL-185-1** Package at 1 piece



**Light/Rain Sensor Adhesive Pad for Citroen, Mercedes, Peugeot**  
**Dimensions: 40 x 35 x 1.5 mm**

- **KPL-189** Package at 5 pieces
- **KPL-189-1** Package at 1 piece



**Light/Rain Sensor Adhesive Pad for Chrysler, Jeep**  
**Dimensions: 40 x 35 x 1.0 mm**

- **KPL-189B** Package at 5 pieces
- **KPL-189B-1** Package at 1 piece



**Light/Rain Sensor Adhesive Pad for Alfa, Audi, Opel, Porsche, Seat, Toyota**  
**Dimensions: 27 x 32.5 x 1.5 mm**

- **KPL-190** Package at 5 pieces
- **KPL-190-1** Package at 1 piece

Detailed vehicle type allocation table on our website at [www.proglass.de](http://www.proglass.de) or upon request!



**Light/Rain Sensor Adhesive Pad for Citroen, Fiat, Mercedes, Nissan, Peugeot, Renault, Smart, VW**

**Dimensions: Ø 43 x 2.0 mm**

■ **KPL-192** Package at 5 pieces

■ **KPL-192-1** Package at 1 piece



**Light/Rain Sensor Adhesive Pad for BMW, Renault**

**Dimensions: Ø 43 x 2.0 mm**

■ **KPL-192C** Package at 5 pieces

■ **KPL-192C-1** Package at 1 piece



**Light/Rain Sensor Adhesive Pad for BMW, Chrysler, Citroen, Dodge, Jeep, Landrover, Mazda, Mercedes, Peugeot, Range Rover**

**Dimensions: 55 x 33 x 1.5 mm**

■ **KPL-193** Package at 5 pieces

■ **KPL-193-1** Package at 1 piece



**Light/Rain Sensor Adhesive Pad for Mercedes**

**Dimensions: 70 x 42 x 1.5 mm**

■ **KPL-197** Package at 5 pieces

■ **KPL-197-1** Package at 1 piece

Detailed vehicle type allocation table on our website at [www.proglass.de](http://www.proglass.de) or upon request!



**Rain Sensor Adhesive Pad for Chevrolet, Honda, Hyundai, Kia, Opel,**  
**Dimensions: 40 x 28 x 1.0 mm**

- **KPR-188**      Package at 5 pieces
- **KPR-188-1**    Package at 1 piece

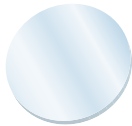

**Light/Rain Sensor Adhesive Pad for Citroen, Fiat, Lancia, Mercedes, Peugeot**  
**Dimensions: Ø 27 x 1.5 mm**

- **KPR-191**      Package at 5 pieces
- **KPR-191-1**    Package at 1 piece



**Light/Rain Sensor Adhesive Pad for VW Group until YOC 98**  
**Dimensions: Ø 28 x 1.0 mm**

- **KPR-194**      Package at 5 pieces
- **KPR-194-1**    Package at 1 piece



**Rain Sensor Adhesive Pad for Alfa, BMW, Mercedes, Rover**  
**Dimensions: 56 x 31 x 1.5 mm**

- **KPR-199**      Package at 5 pieces
- **KPR-199-1**    Package at 1 piece

Detailed vehicle type allocation table on our website at [www.proglass.de](http://www.proglass.de) or upon request!



### ■ KPA-250

#### Applicator for Adhesive Pads and Acrylic Tapes Spray bottle at 250 ml

The applicator helps you to avoid air locks when sticking on sensor pads and adhesive tapes with acrylic adhesive (all items of our range with an item number starting with KPR-, KPL-, TAC-, TAB-).

The liquid applicator enables you to correct the position after sticking the sensor to the glass.

ATTENTION: The applicator KPA-250 must not be used with our gel pads. The high alcohol content would affect the material. If you need to use a liquid applicator you can use clear water or a liquid glass cleaner with a low alcohol content.



### ■ KSX-200

#### Fastener for road charge units, roll at 2.0 m

- dimensions (WxH): 25 x 5.4\* mm
- reclosable fastener tape with self-adhesive backside

\*height for double sided use



### ■ KSR-5025

#### Fastener for road charge units, 10 strips at 5.0 cm

- dimensions (WxH): 25 x 5.4\* mm
- reclosable fastener tape with self-adhesive backside

\*height for double sided use



**Adhesive Pad for Toll Collect Device**  
**Dimensions: 52 x 37 x 0.8 mm**

- **KPM-3752** Package at 5 pieces
- **KPM-3752-1** Package at 1 piece

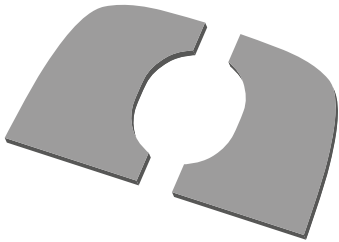

**Adhesive Pads for camera holder for IVECO EUROCARGO & DAF XF**  
**Dimensions: 51 x 41 x 2 mm**

- **KPM-4151** Package at 5 pieces
- **KPM-4151-1** Package at 1 piece

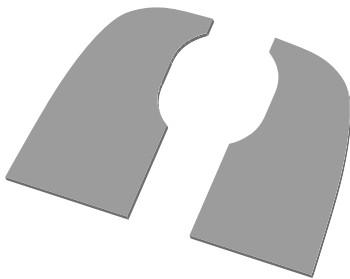

**Adhesive Pads for camera holder for DAF / IVECO / VOLVO**  
**Dimensions: 69 x 41 x 2 mm**

- **KPM-4169** Package at 5 pieces
- **KPM-4169-1** Package at 1 piece

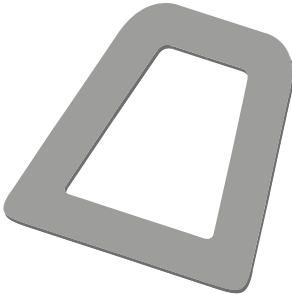

**Toll Collect DSRC Adhesive Pad**  
**Dimensions: 64 x 44 x 1,6 mm**

- **KPM-4464** Package at 5 pieces
- **KPM-4464-1** Package at 1 piece

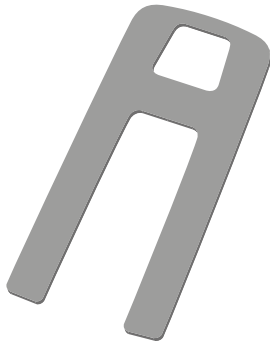

**Adhesive Pad for sensor / camera holder for lane assistant  
SCANIA R & S series**  
Dimensions: 100 x 50 x 1,6 mm

- **KPM-5010** Package at 5 pieces
- **KPM-5010-1** Package at 1 piece

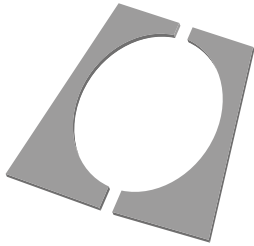

**Adhesive Pad for camera holder  
MAN TGA L/M, XL & MB Actros**  
Dimensions: 62 x 60 x 1,5 mm

- **KPM-6260** Package at 5 pieces
- **KPM-6260-1** Package at 1 piece

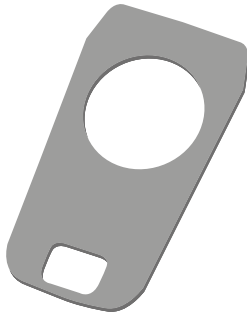

**Adhesive Pad for sensor / camera holder for lane assistant  
MAN TGA L/M, XL, XXL**  
Dimensions: 132 x 74 x 1,1 mm

- **KPM-74132** Package at 5 pieces
- **KPM-74132-1** Package at 1 piece

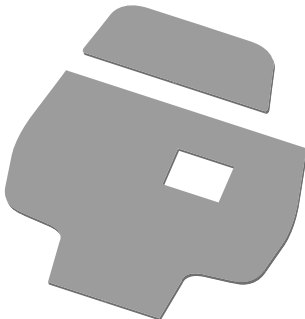

**Adhesive Pad for camera holder  
for lane assistant MB Actros**  
Dimensions: 74 x 74 x 1,6 mm

- **KPM-7474** Package at 5 pieces
- **KPM-7474-1** Package at 1 piece



**Adhesive Pads for antenna holder**

**Dimensions: 164 x 80 x 1,6 mm**

■ **KPM-7488** Package at 5 pieces

■ **KPM-7488-1** Package at 1 piece

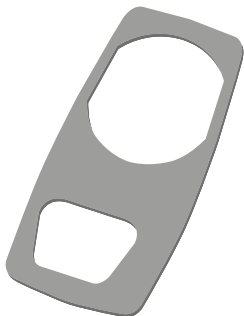

**Adhesive Pad for sensor / camera holder for lane assistant MB Actros**

**Dimensions: 164 x 80 x 1,6 mm**

■ **KPM-80164** Package at 5 pieces

■ **KPM-80164-1** Package at 1 piece

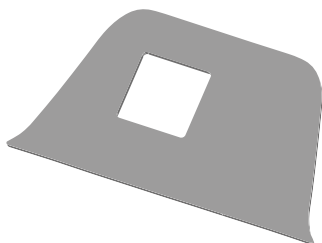

**Adhesive Pad for camera holder for MB Atego, Citaro and Turismo**

**Dimensions: 132 x 74 x 1,1 mm**

■ **KPM-15885** Package at 5 pieces

■ **KPM-15885-1** Package at 1 piece

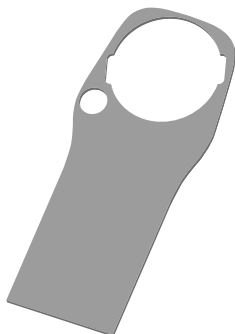

**Adhesive Pad for DSRC device for**

**DAF XD / XF / XG / XG+**

**Dimensions: 180 x 77 x 2,0 mm**

■ **KPM-76180** Package at 5 pieces

■ **KPM-76180-1** Package at 1 piece





■ **SL-350-E**

**Windscreen lift up to 3.50 m high for buses, trucks and trains with electrically operated suction cups**

The ProGlass Windscreen Lift facilitates the fitting of big and heavy windows on busses, trucks or trains.

The new model SL-350-E has a suction unit with three suction cups with a Constant Vacuum per electric pumps system, with an overall load capacity of 280 kg. The lift has a total height (extended) of approx. 3.50 m. This is even high enough to exchange the top windscreen on big coaches.

The whole construction can be easily folded down for transportation in a service truck. Thanks to the integrated transportation casters this can be done by a single person (total weight 154 kg).

All functions are mechanical (no external power source necessary) only lifting and lowering of the window can be supported sensible by using a cordless screwdriver (not included!). By using the Windscreen Lift the manpower requirements for the glazing of big vehicles can be reduced by minimum one person. Therefore it will pay for itself within short time. At the same time the use of this equipment significantly reduces the physical stress and the risk of injuries for the technicians.

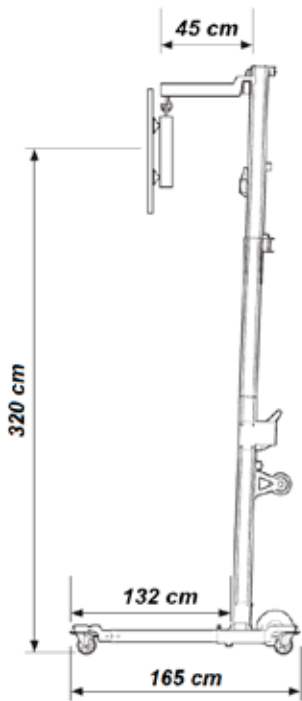



### ■ SL-350-ZV1 Extension 830 mm for Windscreen Lift

The 830 mm long extension arm is perfect for the installation of the upper windscreen on a Neoplan Cityliner or Starliner II. With this extension you can tilt the windscreen to the needed setting angle of 45 degrees.

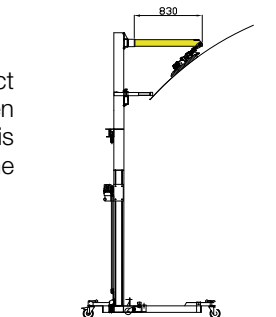

### ■ SL-350-ZV2 Extension 1,540 mm for Windscreen Lift

With the 1,540 mm long extension arm and the long supports the lift can also be used for the installation of windscreens on vans and smaller trucks.



### ■ SL-350-ZS1 Overturning System for Windscreen Lift

For turning the glass from horizontal to installation position with a cordless screwdriver. ATTENTION: Can only be used in connection with the extension 830 mm (SL-350-ZV1) / 1540 mm (SL-350-ZV2).



### ■ SL-350-ZM1 Motor Kit for Windscreen Lift

Gear motor with wire controller for supplementary installation. The cable length of the wire controller is 5.20 m. With industrial socket IEC 309 (200 - 250 V, 16 A, IP44). Power cord not included!

■ **SL-300-S**

**Windscreen Lift up to 3.00 m height for busses, trucks and trains**

The ProGlass Windscreen Lift facilitates the fitting of big and heavy windows on busses, trucks or trains.

The model SL-300-S has a suction unit with two suction cups with an overall load capacity of 140 kg. The lift has a total height (extended) of approx. 3.00 m. This is high enough to install the windscreen on most busses and trucks.

The whole construction can be easily folded down for transportation in a service truck. Thanks to the integrated transportation casters this can be done by a single person (total weight 120 kg). All functions are mechanical (no external power source necessary) - only lifting and lowering of the window can be supported sensible by using a cordless screwdriver (not included!).

By using the Windscreen Lift the manpower requirements for the glazing of big vehicles can be reduced by minimum one person. Therefore it will pay for itself within short time. At the same time the use of this equipment significantly reduces the physical stress and the risk of injuries for the technicians.

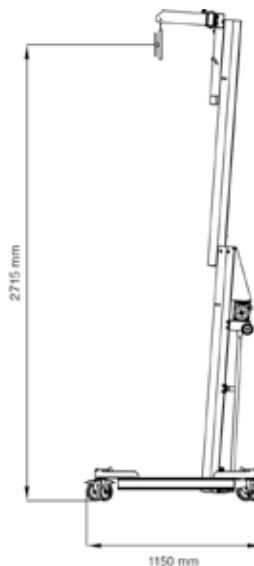
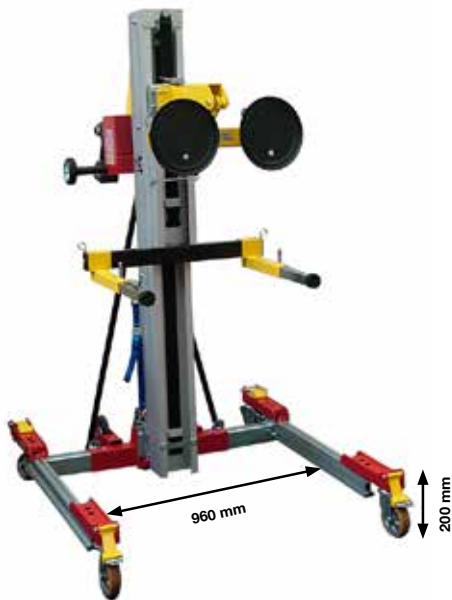

### ■ PFN-300

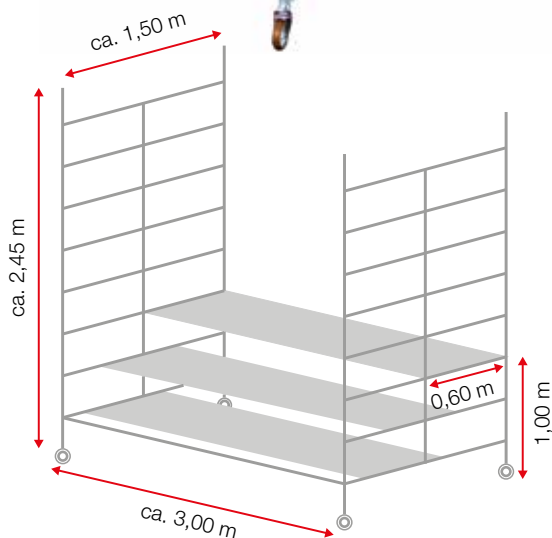

### Mobile Scaffold for bus and truck work

Finally a safe working space for the glazing of busses and trucks!

The construction platform with its 4 big swivelling castors ( $\varnothing$  150 mm, gummed, with brake) can be positioned easy and in a safe manner. In addition, all castors are vertically adjustable to adapt the scaffold on uneven ground.

Two fitters can comfortably move the windscreen to the vehicle: They both have enough space to stand on the platform as it is 3.0 m wide. The steps are fixed on the levels of 50, 75 and 100 cm.

Assembly and disassembly of the scaffold is quick and easy to handle without the use of tools. The maximum weight of a single part is of only 24 kg, so that it can be done completely by one person.

total weight: 121 kg

loading length (max.): 3.07 m

loading height (max.): 1.54 m

- the ideal scaffold for the glazing of busses and trucks
- working height ca. 3 m
- TÜV approved, load capacity 200 kg/m<sup>2</sup> (scaffold class 3) in accordance with EN1004
- the platform size with 2.90 m x 0.60 m offers a safe working space
- all parts are easy to handle (max. weight 24 kg)
- quick assembly without the use of tools thanks to the patented locking system

### ■ PFK-050



### Work Platform StepTop, max. load 150 kg

- foldable work platform with water-proof and non-slip phenolicresin panel (109 x 30 cm)
- ideal for working on vans and small trucks (height of platform: 50 cm)
- safety locks on both sides prevent unintentional folding
- multiple riveted robust aluminum step/rail joints with 4 additional stable corner braces
- quick and space-saving storage (13.5 cm thick)
- non-slip, large dimensioned foot caps ensure safe foothold

■ **WPRO6-3IN1-D WRD PRO6 System 3-in-1, Deluxe Kit**



This is the all-in-one solution from WRD Glass Tools for the removal, transportation and installation of bonded vehicle glasses. Each of the three vacuum pump suction lifters has a different configuration, which makes this multifunctional tool kit extremely versatile. This is probably the most compact and professional tools solution for the up-to-date windscreen removal with cutting line and cordless drill (similar to the famous SPIDER removal system) and the back-friendly installation of bonded windscreens by only one person. At the same time the suction lifters can be used for the safe handling and transportation of all glasses.

Scope of delivery as shown on picture!

■ **WPRO6-INS4 WRD PRO6 Installation System with 4 suction lifters**



- Kit contains:
- 4 vacuum pump suction lifters WPRO6-B
  - 1 extended arm WPRO6-EA
  - 1 double hook kit WPRO6-DH
  - 1 tool tote WPRO6-TT
  - 1 instruction manual

Maximum load 20 Kg

■ **WPRO6-EA-3**

**Extended arm for WPRO6 with Triple Handle**

Extended arm for WPRO6 with three handles for optimum handling.



The installation system from the WRDGlass Tools PRO6-INS4 series allows simple installation of windscreens by just one person. The ingenious system is suitable for car and van windscreens and allows windscreens to be fitted to almost any model of vehicle. This also includes severely curved windscreens, or those covered by car body parts.

The system is uniquely compact with 4 suction cups and three system accessories. This makes it the perfect mobile solution for one-man installation - both as a mobile service or in the workshop.

■ **PCG-180-F**

**Milwaukee Cordless Caulking Gun 18 V for 310 ml cartridges and sachets up to 600 ml**



- long 600 ml aluminium barrel for big sachets
- high squeezing pressure of 459 Kg / 4500 N for a simple processing of highly viscous material
- up-to-date lithium-ion battery technology for maximum performance at a minimum weight (power tool including battery 2.9 kg)
- variable speed trigger for optimal control
- Vmax restriction on 6-speed wheel (feed rate 0 - 9 mm/s)
- remaining content easily visible by the position of the rack
- no dripping of sealant thanks to electronic rack release function after disengaging the trigger
- rack disengages automatically for fast reloading
- ergonomically shaped, non-skid 2-component handle
- delivered with one 18 V Li-Ion battery pack (2.0 Ah)
- Milwaukee 30-min. quick charger included

■ **PCG-180-FT**

**Milwaukee Cordless Caulking Gun 18 V for 310 ml cartridges and sachets up to 600 ml with clear barrel**



- Long clear barrel for cartridge and sachets up to 600 ml.
- Incredibly high squeezing pressure of 459 kg / 4500 N for a simple processing of highly viscous material.
- Up-to-date lithium-ion battery technology for maximum performance at a minimum weight (power tool including battery 2.9 kg).
- Highest application accuracy of all battery guns on the market. Variable speed trigger for optimal control.
- Vmax restriction on 6-speed wheel (feed rate 0 9 mm/s). Remaining content easily visible by the position of the rack.
- No dripping of sealant thanks to electronic rack release function after disengaging the trigger.
- Rack disengages automatically for fast reloading. Ergonomically shaped, nonskid 2-component handle.
- Delivered with one 18 V Li-Ion battery pack (2.0 Ah) Milwaukee 30-Min. quick charger included.

■ **PCG-180-KF Milwaukee Cordless Caulking Gun 18 V for 310 ml cartridges and sachets up to 400 ml**



- ProGlass exclusive remodeling with 400 ml aluminium barrel
- high squeezing pressure of 459 Kg / 4500 N for a simple processing of highly viscous material
- up-to-date lithium-ion battery technology for maximum performance at a minimum weight (power tool including battery 2.7 kg)
- variable speed trigger for optimal control
- Vmax restriction on 6-speed wheel (feed rate 0 - 9 mm/s)
- remaining content easily visible by the position of the rack
- no dripping of sealant thanks to electronic rack release function after disengaging the trigger
- rack disengages automatically for fast reloading
- ergonomically shaped, non-skid 2-component handle
- delivered with one 18 V Li-Ion battery pack (2.0 Ah)
- Milwaukee 30-min. quick charger included

■ **PCG-180-KFT Milwaukee Cordless Caulking Gun 18 V for 310 ml cartridges and sachets up to 400 ml with clear barrel**



- high squeezing pressure of 459 Kg / 4500 N for a simple processing of highly viscous material
- Up-to-date lithium-ion battery technology for maximum performance at a minimum weight (power tool including battery 2.7 kg)
- highest application accuracy of all battery guns on the market
- Variable speed trigger for optimal control
- Vmax restriction on 6-speed wheel (feed rate 0 - 9 mm/s)
- Remaining content easily visible due to the transparent barrel
- No dripping of sealant thanks to electronic rack release function after disengaging the trigger
- Rack disengages automatically for fast reloading
- Ergonomically shaped, nonskid 2-component handle
- Delivered with one 18 V Li-Ion battery pack (2.0 Ah)
- Milwaukee 30-Min. quick charger included

■ **PCG-180**



**Milwaukee Cordless Caulking Gun 18 V for 310 ml cartridges**

- one-side open plastic barrel for quick and easy reloading of cartridges
- high squeezing pressure of 459 Kg / 4500 N for a simple processing of highly viscous material
- up-to-date lithium-ion battery technology for maximum performance at a minimum weight (power tool including battery 2.6 kg)
- variable speed trigger for optimal control
- Vmax restriction on 6-speed wheel (feed rate 0 - 9 mm/s)
- remaining content easily visible by the position of the rack
- no dripping of sealant thanks to electronic rack release function after disengaging the trigger
- rack disengages automatically for fast reloading
- ergonomically shaped, non-skid 2-component handle
- delivered with one 18 V Li-Ion battery pack (2.0 Ah)
- Milwaukee 30-min. quick charger included

■ **PCG-180-URS Conversion Kit for Milwaukee 600 ml (PCG-180-F)**



With this conversion kit you can convert your Milwaukee caulking gun PCG-180 or PCG-180-KF / KFT without effort into a caulking gun with 600 ml aluminium barrel. The converted caulking gun is equal to our item number PCG-600-F. The kit includes all necessary parts and the tool can be rebuild at any time.



■ **BP-180**

**Milwaukee Li-Ion Battery 18 V (2.0 Ah)  
for PCG-180 /-F /-FT /-KF /-KFT**



■ **BP-184**



**Milwaukee Li-Ion battery 18 V (4,0 Ah) suitable for  
PCG-180 /-F /-FT /-KF /-KFT & ANT-M18**



■ **PBA-1827**

**Milwaukee Quick Charger (30 min.)  
for PCG-180 /-F /-FT /-KF /-KFT**

■ **PCG-120-KF Milwaukee Cordless Caulking Gun 12 V for 310 ml cartridges and sachets up to 400 ml**



- Up to 1780 N of force
- REDLINK™ overload protection electronics in tool and battery pack deliver best in class system durability
- Optimised performance with all construction adhesives and cool temperatures
- Variable speed trigger for optimal control
- Anti-drip feature prevents unwanted dripping when trigger is released
- Dial control with 6 speed settings allows for maximum bead control
- Large robust plunger design ensures constant flow, reduces blow back and expels all sealant from cartridge
- Individual battery cell monitoring optimises tool run time and ensures long term pack durability
- REDLITHIUM™ battery pack provides superior pack construction, electronics and fade-free performance to deliver more run time and more work over pack life
- Flexible battery system: works with all MILWAUKEE® M12™ batteries
- Delivered with one 12 V Li-Ion battery pack (2.0 Ah)
- Milwaukee 40-Min. quick charger included

■ **BP-M12 Li-Ion Battery Pack 12 V (2.0 Ah) for PCG-120-KF**

■ **AKP-036 Panasonic Cordless Caulking Gun 3.6 V for cartridges and sachets up to 400 ml**



- short 400 ml aluminium barrel for cartridge and sachet use
- powerful and robust cordless caulking gun with an ejection pressure of 2500 N
- light-weight despite powerful (weight incl. battery: 2.16 kg)
- speed regulator build into handle for controlled application
- delivered with one 1,5 Ah (Li-Ionen) battery pack
- Panasonic 30-min. quick charger included

■ **BP-036 Li-Ion Battery Pack 3.6 V, 1.5 Ah for AKP-036**

■ **AKP-472**

**Cordless Caulking Gun 7.2 V**



- short 400 ml aluminium barrel for cartridge and sachet use
- powerful caulking gun with an ejection pressure of 4500 N
- Variable speed trigger for controlled application
- Vmax restriction with control dial
- Remaining content easily visible by the position of the rack
- No dripping of sealant thanks to electronic rack release function after disengaging the trigger
- Weight (power tool incl. battery): 1290 g
- Delivered with one 7.2 V, 1.5 Ah Li-Ion battery pack
- 90-Min. charger included

■ **BP-472**

**Li-Ion Battery Pack 7.2 V (1.5 Ah) for AKP-472**

■ **AKP-075/L-01**

**Aluminium front cap for battery caulking guns**



The robust front cap is made of die casted aluminium and can be used for most caulking guns from COX, Metabo, Milwaukee and Panasonic.

■ **TM-TN-0022**

**Plastic front cap for caulking guns**



The robust front cap is made of plastic and can be used for most caulking guns from COX, Metabo, Milwaukee and Panasonic.

■ TN-310



**COX Pneumatic Caulking Gun for 310 ml cartridges  
max. operating pressure 10 bar**

- pneumatic caulking gun without piston - compressed air streams directly towards the bottom of the cartridge (the cartridge must not be damaged or dented at the bottom)
- **NOT** suitable for sachets!
- regulation of ejection speed with integrated valve

■ TN-600



**COX Pneumatic Caulking Gun for 600 ml sachets  
max. operating pressure 10 bar**

- pneumatic caulking gun with floating piston - compressed air streams directly towards the bottom of the floating piston which presses towards the sachet
- **NOT** suitable for cartridges!
- regulation of ejection speed with integrated valve

■ TM-310



**Pneumatic Caulking Gun COX AirFlow3  
for 310 ml cartridges**

Pneumatic caulking gun without piston compressed air streams directly towards the bottom of the cartridge (the cartridge must not be damaged or dented at the bottom) Not suitable for sachets! Regulation of ejection speed with integrated valve.

■ TM-600



**COX Pneumatic Caulking Gun for cartridges and sachets from  
310ml up to 600ml**

- Features of the compact Pneumatic Caulking Gun
- Very handy because of a perfect length and a ergonomic handle
  - This gun is usable for cartridge 290-310ml even for sachet from 300-600ml
  - Easy change from cartridge to sachet converting into 10 sec because of a special quick release system.



■ **CT-318**

**COX Manual Caulking Gun 18:1  
for 310 ml cartridges**

- the trigger ratio 18:1 facilitates ejection of high viscosity sealants compared to standard caulking guns
- solid construction
- approved long-living mechanism



■ **AV-418**

**COX Manual Caulking Gun 18:1  
for cartridges and sachets up to 400 ml**

- the trigger ratio 18:1 facilitates ejection of high viscosity sealants compared to standard caulking guns
- solid construction
- approved long-living mechanism



■ **AC-325**

**COX Manual Caulking Gun 26:1  
for 310 ml cartridges**

- the trigger ratio 26:1 enables to eject even high viscosity auto glass sealants
- heavy construction for long durability
- the established mechanism is equipped with a wear compensating device. That means, even after longer use, no clearance at the trigger



■ **AC-625C**

**COX Manual Caulking Gun 26:1  
for cartridges and sachets up to 600 ml**

- the trigger ratio 26:1 enables to eject even high viscosity auto glass sealants
- heavy construction for long durability
- the established mechanism is equipped with a wear compensating device. That means, even after longer use, no clearance at the trigger



■ AV-435

**COX Manual Caulking Gun 35:1  
for cartridges and sachets up to 400 ml**

- the handy gun enables over the perfect trigger ratio to eject even high viscosity glass sealants
- the trigger ratio 35:1 facilitates ejection of high viscosity sealants compared to standard caulking guns
- solid construction
- approved long-living mechanism



■ 2P1021

**Plastic Adaptor for sachets**

This plastic adaptor is part of every COX caulking gun for sachets and also parts of some battery powered caulking gun for sachets. Whenever a sachet was clamped in your gun you should replace this adaptor.



■ ASB-001

**Adaptor Kit for Sachets**

Sachet clamped? Or even ripped? We know the problem! And here is the solution: An adaptor that properly fits the cylinder of your gun. That does not clamp the sachet. And that empties the sachet economically. Suitable for following products from our range: AV-418, AV-618, PCG-180-KF and many others on the market!



■ **AGR-1105**

**Rubber Spacers round, black (Ø 11 mm, height 5 mm)  
pad with 55 pieces**

These self-adhesive round rubber spacers are equal with the ones used by BMW. But of course you can use them also on all other vehicles as a universal spacer.



Ø 11 mm

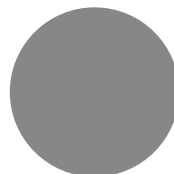

5 mm

■ **AGT-1105**

**Rubber Spacers round, clear (Ø 11 mm, height 5 mm)  
Pad with 55 pieces**

These self-adhesive round transparent rubber spacers are equal with the ones used by Opel. But of course you can use them also on all other vehicles as a universal spacer.



5 mm



■ **AGQ-1265**

**Rubber Spacers, square, black (12.6 x 12.6 mm, height 5.7 mm) pad with 50 pieces**

These self-adhesive quadrate rubber spacers are equal with the ones used by Mini Countryman R60. But of course you can use them also on all other vehicles as a universal spacer.

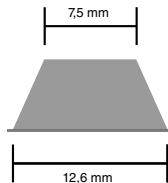

■ **AGV-0906**

**Rubber Spacers rectangular (LxWxH: 30 x 9 x 6 mm) package at 100 pieces**

Self-adhesive rectangular rubber spacers. You can cut them according to your needs. They are a practically irreplaceable utility when installing windscreens.

Thanks to the self-adhesive underside you can put them wherever you want.

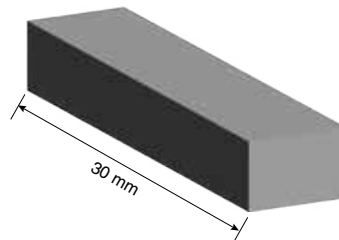
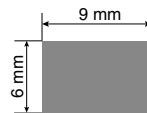
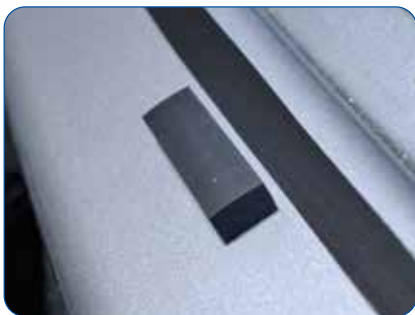

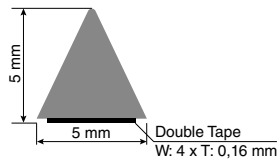

■ **AGD-0505**

**Rubber Spacers triangular (LxWxH: 20 x 5 x 5 mm), package with 100 pieces**

Self-adhesive triangle rubber spacers. You can cut them according to your needs. They are a practically irreplaceable utility when installing windcreens. Thanks to the self-adhesive underside you can put them wherever you want.

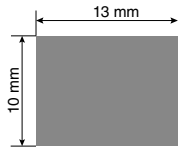
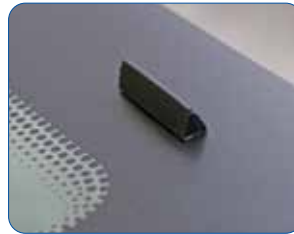
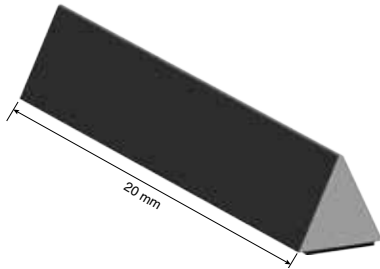

■ **AGV-1310**

**Rubber Spacers rectangular (LxWxH: 25 x 13 x 10 mm), package at 100 pieces**

Rectangular rubber spacers (not self-adhesive). You can cut them according to your needs. They are a practically irreplaceable utility when installing windcreens.

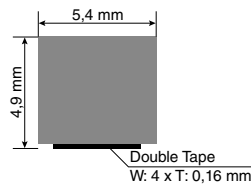
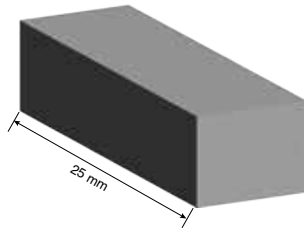

■ **AGV-5449**

**Rubber Spacers rectangular (25 x 5,4 x 4,9 mm), package with 100 pieces**

Self-adhesive rectangular rubber spacers. You can cut them according to your needs. They are a practically irreplaceable utility when installing windcreens. Thanks to the self-adhesive underside you can put them wherever you want.

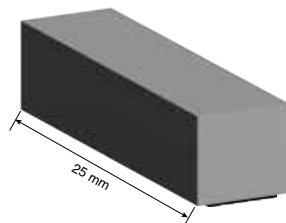

■ **KB-1228**

**Rubber Spacers rectangular (LxWxH: 25 x 12 x 10 mm)  
package with 50 pieces**

Rectangular rubber spacers.(no self-adhesive). You can cut them according to your needs. They are a practically irreplaceable utility when installing windscreens.

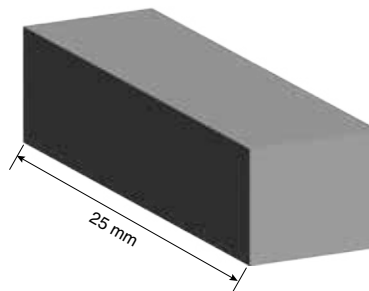
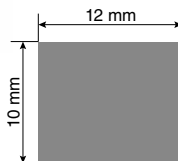

■ **AKV-2515**

**Spacer pads, rectangular,  
package at 8 pieces**

- dimensions (LxWxH): 25 x 15 x 5.4\* mm
- reclosable fastener with self-adhesive backside

\*height for double sided use

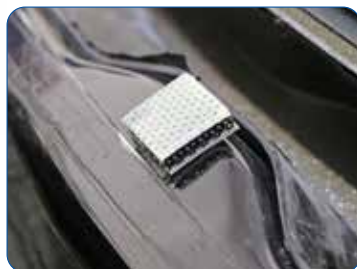
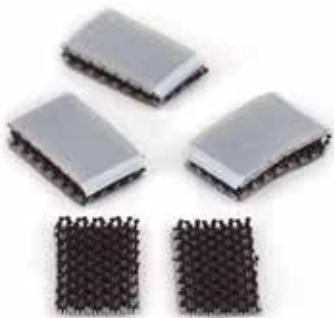

■ **TO-1437** Pinchweld Cleaning Brushes  
package at 10 pieces

■ **TO-1437-100** Pinchweld Cleaning Brushes  
package at 100 pieces



A clean pinchweld is the base for a properly installed and leak-proof windscreen. But it is not always necessary to use a vacuum cleaner. Many times a brush will be sufficient to clean the pinchweld before cutting down the old polyurethane. The brushes are made of horsehair that is soft to the paint but strong enough to brush away the dirt.

■ **KFB-230** Pinchweld Cleaning Brush, package at 2 pieces



The solid brush made of galvanized steel with nylon bristles is well suitable for the removal of tenacious stain from the pinchweld. Also for the mobile service, wehn no vacuum cleaner is available, this brush does a good job.

■ **KFP-050** Pinchweld Cleaning Brush



A clean pinchweld is the base for a properly installed and leak-proof windscreen. But it is not always necessary to use a vacuum cleaner. Many times a brush will be sufficient to clean the pinchweld before cutting down the old polyurethane. The brush are made of synthetic hair that is soft to the paint but strong enough to brush away the dirt.



■ **DM-1094**

**Applicators small, lint-free, 150 mm long, 100 pieces per plastic bag**

Small head applicators



■ **RS-1818**



**Cleaning and Primer Sponge, 100 mm x 18 mm x 18 mm, bag at 50 pieces**

Foam-based cleaning and primer stick for cleaning and priming the screen printing on automotive glasses. Caution: For single use only! Always apply in one direction only – do not wipe back and forth. Otherwise absorbed impurities will be released back onto the surface. Only ever use new and clean sticks to apply primer.



■ **APM-100-B**

**Mini-Applicators, lint-free, 125 mm long, 100 pieces per plastic bag**

These applicators with a smaller diameter should be used on all vehicles with a very narrow pinchweld. The small head facilitates a clean application without primer being visible after the installation.



Ø ca. 15 mm

ca. 125 mm



■ **AP-100**

**Applicators, lint-free, 105 mm long,  
100 pieces per carton**

■ **AP-100-B**

**Applicators, lint-free, 105 mm long,  
100 pieces per plastic bag**

■ **AP-25**

**Applicators, lint-free, 105 mm long,  
25 pieces per plastic bag**

■ **AP-2500**

**Applicators, lint-free, 105 mm long,  
2.500 pieces in a corrugated cardboard box (not shown)**

Applicators for clean and exact application of black and transparent primers, cleaning agents, etc.

The applicator tufts are made of pure cotton, virtually lint-free, solid and tightly equipped, for an evenly covering application.

Ø ca. 22 mm



ca. 105 mm

■ **APL-100**

**Applicators, lint-free, 130 mm long,  
100 pieces per carton**

■ **APL-100-B**

**Applicators, lint-free, 130 mm long,  
100 pieces per plastic bag**

■ **APL-25**

**Applicators, lint-free, 130 mm long,  
25 pieces per plastic bag**

■ **APL-2500**

**Applicators, lint-free, 130 mm long,  
2.500 pieces in a corrugated cardboard box (not shown)**

The 130 mm applicators keep your fingers clean.

With the longer wire they also reach the bottom of most 250 ml bottles. All other features of the APL applicators are the same than of our AP applicators.

Ø ca. 22 mm

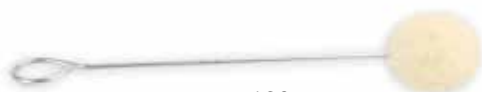

ca. 130 mm

■ **PML-145-1**

**ProGlass Installation Suction Lifter**

The installation suction lifter makes it possible to align a freshly installed glass with millimetre precision and to fix it securely until the save drive-away time is obtained.

- Precise alignment of the glass by simply twisting the handle
- Two bell-shaped rubber pads with large seal for easier handling and additional safety against coming off
- Pin-jointed heads bridge angles of max. 30°
- Load capacity for each lifter is 60 kg
- Heads made of shock-resistant plastic, handle made of powder-coated aluminium
- Diameter of suction cups 150 mm

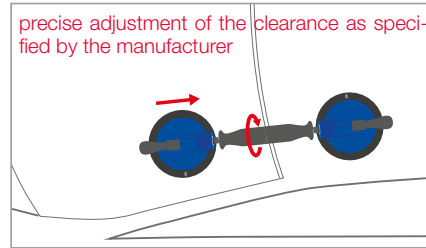
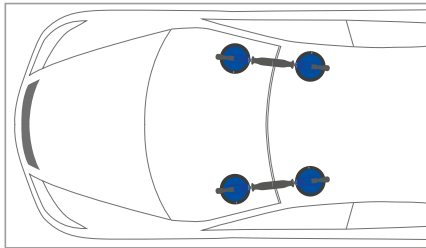

■ **FDS-700**

**Flexible Double Suction Cup**

The flexible double suction cup is the best to secure a freshly bonded windscreen. These suction cups stay exactly in position and will not let the glass move a single millimeter! Made of two plastic suction heads with 115 mm rubber disks, connected with a foam covered steel cable (cable length 42 cm).





■ **ML-101**

**Assembly Jig 10 x 1.0 mm package at 2 pieces**

For a professional windscreen installation in accordance with the manufacturer's instructions you must observe the correct clearance between the glass and the car body. As bonded glasses must not be moved once they have been set, it is beneficial to ensure the correct clearance during the installation process.

With its 1.0 mm thick plastic discs the assembly jig permits an auto glass installation accurate to the last millimetre. Simply position as many discs as needed between glass and pinchweld. The assembly jig can be fixed either on the glass or on the car body.

At the same time the assembly jig can be used as a clearance gauge for all car body jobs (e. g. when mounting fenders or aligning doors and hoods).



■ **SSH-290**

**Window Holder Set**

Holds the side window while you are working on the window lifter so that you have both hands free. This window holder set also keeps a windscreen from sliding down while the polyurethane hardens (fix one end on the glass, the other end on top of the car).

Improved version: More stability, due to the cast-in thread. Cable length 45 cm





■ **PRS-118**

**ProGlass Rust Remove Pencil**

A practical pen to quickly and tidily erase small corroded points. The „core“ of the pen consists of a 3 cm long bundle of fibre glass with a very good abrasive effect. Delivery with two additional bundles of fibre glass, stored inside the shaft, for replacement.



■ **KS-125**

**Body Filler Applicator Set, in 3 parts**

A perfect means to trim and correct fresh PU beads after setting a new glass or to fill up gaps. Remaining adhesive can easily be pulled of the plastic after it is cured.



■ **ABS-025**

**ProGlass Airbag Stickers  
package of 25 pieces**

Almost every car manufacturer has an own airbag warning sticker for the windscreen. Our stickers help you to save time and money to purchase different stickers from the manufacturers. Our multi-useable airbag sticker is made of transparent adhesive foil and can be used for all passenger cars with driver airbag, passenger airbag and side-impact airbag.

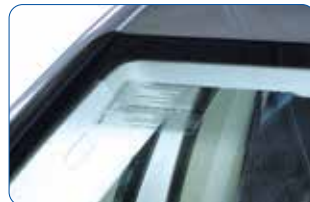



# OCTOPUS

## DIGITAL

### ProGlass OCTOPUS DIGITAL Multi-Brand Calibration device for advanced driver assistance systems

- Calibration device for precise front camera calibration
- Full-size digital target display as per manufacturer's specification on a 75-inch 4K display (no physical calibration targets/panels required)
- Easy positioning with the OCTalign alignment software included (incl. Android tablet)
- Automatic display of the required target and setting of the correct height based on the vehicle selection
- Digital distance measurement with real-time transmission to the tablet
- Protocol on the correct alignment of the calibration device
- Cost-effectively expandable for front radar calibration
- System independent of the diagnostic software - use your existing diagnostic device or the TEXA diagnostic software IDC5 CAR distributed by us
- Perfectly combinable with the CL101 wheel alignment system for input measurement

■ **OCD-375P**



**OCTOPUS Digital Pro multi-brand calibration device for driver assistance systems, incl. service agreement for 12 months database updates and 12 months licence for all digital targets**

Scope of delivery:

- Chassis with electric height adjustment
- Flat screen (75-inch 4K display) and mini PC
- Measuring bar with scales (can be combined with wheel alignment system)
- Wheel hub stand with Bluetooth laser distance meter (2 units)
- Android tablet with OCTalign alignment software
- All available digital targets (12-month license included)
- Continuously updated vehicle database (12-month license included)



*quicklink to the product video*



■ **OCD-375-SH** **Cover for OCTOPUS Digital**



Cover to protect the OCTOPUS Digital against dust and moisture



# OCTOPUS

## ProGlass OCTOPUS Multi-brand calibration device for driver assistance systems

- high-precision mechanical calibration device
- Optimal measurement accuracy according to the highest OEM specifications
- Fast and exact alignment using point and line lasers
- Maximum efficiency thanks to the patented swivel arm system
- combined device for cars and trucks (optional extension)
- Targets / calibration boards available for many brands (optional accessories)
- Optimized for use with TEXA diagnostic software IDC5 CAR / TRUCK (including assignment as an accessory KIT – we are official TEXA sales partner)
- Compatible with existing diagnostic devices from other manufacturers \*
- Compatible with existing boards from other manufacturers \*
- Calibration of front radar systems on cars and trucks, incl. lidar / laser scanner (optional extension)

\* For further information, please contact our customer service or your local sales force.

### ■ OCC-300P



*quicklink to the product video*



## **OCTOPUS Car Pro** **Multi-Brand Calibration device for advanced driver assistance systems**

Device for calibrating the front camera / multifunction camera on cars and vans.

The PRO version already contains the wheel mounts with rotating mirror scales and the adjustment bar with laser scales. This enables calibration via the geometric travel axis, in accordance with the manufacturer's specifications of the VW group brands.

Scope of delivery:

- OCTOPUS PRO trolley with adjustment bar and laser scales
- 2 wheel mounts with mirror scales
- Cross line laser
- Accessory case
- Central holder
- Swivel arm
- Target holder for cars / transporters
- Double target VAG / Mazda / Mercedes (item OCC-DT01)
- Single target FCA / PSA / Opel / Kia / Hyundai (item OCC-ST01)
- Operating and assembly instructions

### ■ OCC-300B

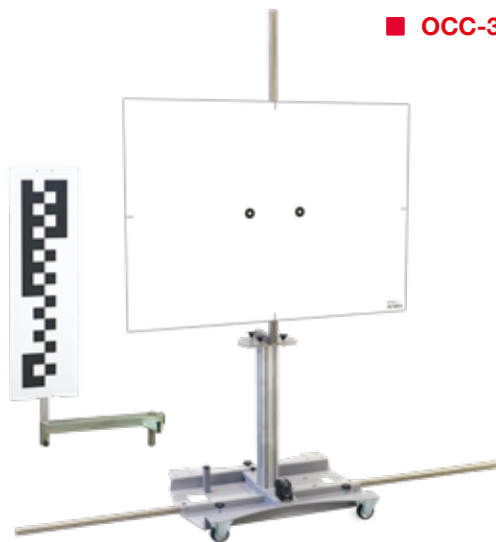

*quicklink to the product video*



## **OCTOPUS Car Basic** **Multi-Brand Calibration device for advanced driver assistance systems**

Device for calibrating the front camera / multifunction camera on cars and vans.

With the BASIC version, the calibration is carried out with the included cross line laser via the vehicle's symmetry axis. The system thus meets the requirements of most vehicle manufacturers

Scope of delivery:

- OCTOPUS BASIC trolley
- Cross line laser
- Central holder
- Swivel arm
- Target holder for cars / transporters
- Double target VAG / Mazda / Mercedes (item OCC-DT01)
- Single target FCA / PSA / Opel / Kia / Hyundai (item OCC-ST01)
- Operating and assembly instructions

■ **OCT-400P**

**OCTOPUS PRO TRUCK**  
**Multi-Brand Calibration device for advanced driver assistance systems**

Device for calibrating the front camera / multifunction camera on trucks.

The PRO version already contains the wheel mounts with rotating mirror scales and the adjustment bar with laser scales. This enables calibration via the geometric travel axis, in accordance with the MAN manufacturer's specifications.

Scope of delivery:

- OCTOPUS PRO trolley with adjustment bar and laser scales
- 2 wheel mounts with mirror scales
- Cross line laser
- Accessory case
- Central holder
- Swivel arm
- Target holder for trucks
- Single target MAN / Scania / Iveco (item OCT-ST01)
- Single target Volvo / Renault (item OCT-ST02)
- Operating and assembly instructions

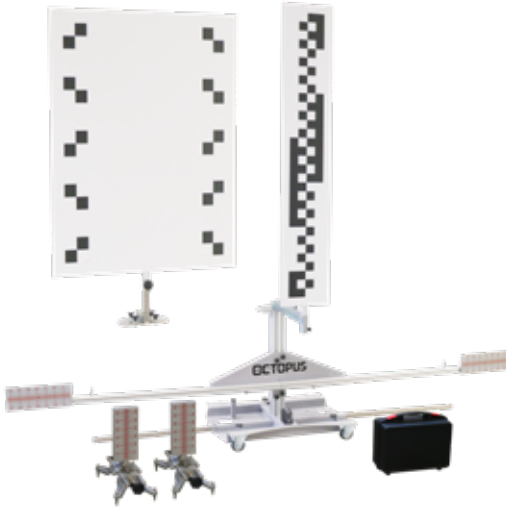

■ **OCT-400B**

**OCTOPUS Truck Basic**  
**Multi-Brand Calibration device for advanced driver assistance systems**

Device for calibrating the front camera / multifunction camera on trucks.

With the BASIC version, the calibration is carried out with the included cross line laser via the vehicle's symmetry axis. The system thus meets the requirements of most vehicle manufacturers.

Scope of delivery:

- OCTOPUS BASIC trolley
- Cross line laser
- Central holder
- Swivel arm
- Target holder for trucks
- Single target MAN / Scania / Iveco (item OCT-ST01)
- Single target Volvo / Renault (item OCT-ST02)
- Operating and assembly instructions

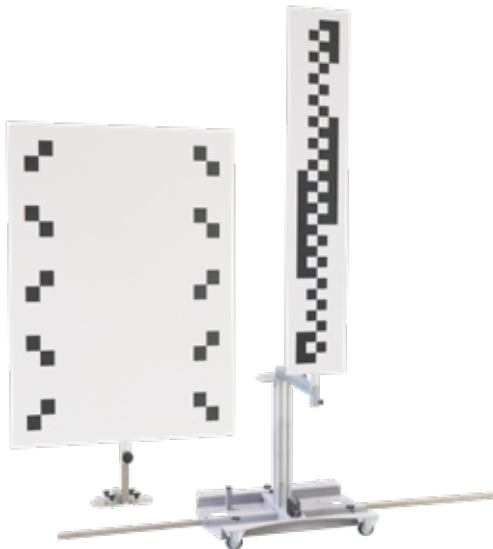

### ■ OCT-3040G Upgrade kit geometric travel axis for OCTOPUS Car & Truck



The set contains the wheel mounts with rotating mirror scales and the adjustment bar with laser scales, including the necessary accessories. In this way, an OCTOPUS Basic is upgraded to an OCTOPUS Pro.

### ■ OCC-300-E Extension kit for trucks (from OCTOPUS Car to Truck), including MAN / Scania and Volvo / Renault targets

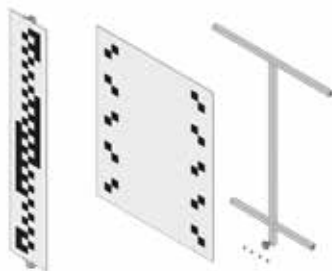

The set contains all the parts required to expand an OCTOPUS car into an OCTOPUS truck. This allows the device for cars to be used very easily for calibrating cars and trucks.

### ■ OCT-400-E Extension kit transporter / car (from OCTOPUS truck to car)

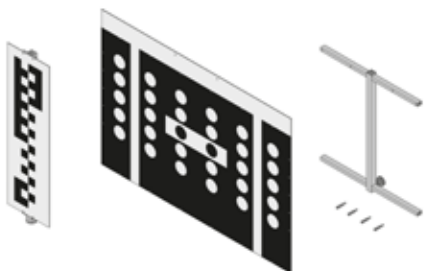

The set contains all the parts required to expand an OCTOPUS truck into an OCTOPUS car. This means that the device for trucks can be used very easily for the calibration of trucks and cars.

### ■ OCC-RSS OCTOPUS Tyre Clamp Set for installing the wheel mounts using plastic centring pins and tyre claws



The addition of the tyre clamp set to the OCTOPUS wheel mounts enables safe and damage-free mounting of the wheel mounts on very sensitive aluminium rims. The original stainless steel positioning pins are replaced by aluminium pins with plastic caps. (2 different versions). The plastic centring pins are supplemented by adjustable tyre claws that securely clamp the wheel mount onto the wheel.



■ **OCC-RT01**

**Radar reflector with angle adjustment for OCTOPUS Car**



The radar reflector enables the calibration of front radar sensors on most cars and vans. For efficient and precise adjustment of the tilt angles specified in the calibration process, the reflector is attached to the measuring beam in different stages, which ensures very fast and error-free adjustment. Supplied with hanging tray and point laser for precise alignment. Suitable for the Octopus Digital and for all analogue Octopus calibration devices with radar extension (optional accessory).

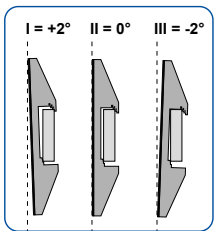

■ **OCC-RT02**

**Lidar target with magnetic attachment for OCTOPUS Car**



The lidar target enables the calibration of the laser scanner/lidar sensor on Audi and VW models. The target is attached to the measuring bar with magnets for easy and error-free handling. Supplied with hanging tray for the BOX-1 cross line laser (not included) for quick and precise alignment. Suitable for Octopus calibration devices OCC-300 with radar extension (optional accessory).



■ **OCD-RT02**

**Lidar target with hook-on fixture for OCTOPUS Car**



The lidar target enables the calibration of the laser scanner/lidar sensor on Audi and VW models. For easy handling, the target is attached to the measuring bar and centred. Supplied with hanging tray for the BOX-1 cross line laser (not included) for quick and precise alignment. Suitable for the Octopus Digital and Octopus Eco with measuring bar (optional accessory).



■ **OCC-RE1**



**Radars extension for OCTOPUS Car Pro**

The radar extension for the Octopus Car Pro consists of an additional measuring bar for holding the radar targets, which is mounted in front of the original crossbar. This extension enables the use of the RT01 radar reflector and RT02 lidar target, each up to a sensor height of max. 600 mm. ATTENTION: In some cars/SUVs and vans, the sensor is mounted higher! Calibration of these sensors is not possible. Suitable for the Octopus Car Pro.



■ **OCC-RE2**



**Radars extension for OCTOPUS Pro**

The radar extension for the Octopus (Car & Truck) Pro consists of an additional measuring beam mounted above the front fixed castors to accommodate the radar targets. This extension enables the use of the RT01 radar reflector and RT02 lidar target, each up to a maximum sensor height of 1,1500 mm. This means that the radar/lidar sensors can be calibrated on almost all cars, SUVs and vans. The radar targets for trucks are also compatible with this extension. Suitable for Octopus Car Pro and Octopus Truck Pro.



■ **OCC-200E**

**ProGlass OCTOPUS Car ECO**  
**Multi-brand calibration device for driver assistance systems**

Including targets Renault/Smart und FCA/PSA/Opel/Kia/Hyundai.



Scope of delivery:

- precise mechanical calibration device for front camera calibration
- Calibration based on the vehicle symmetry axis in accordance with the specifications of most vehicle manufacturers
- Fast and precise alignment using line laser and laser receiver
- Targets / calibration boards available for many brands (optional accessories)
- Compatible with existing boards from other manufacturers\*
- Easily transportable solution - very suitable for mobile use
- Quick assembly and space-saving storage thanks to the foldable chassis

**OCTOPUS** *ECO*

*quicklink to the product video*

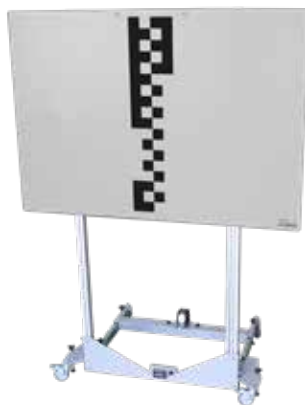

\* For further information, please contact our customer service or your local sales force.

■ **OCC-MB01** **Measuring beam set for OCTOPUS Eco**



The measuring beam set for the Octopus Car Eco consists of a cross-beam with adjustable scales and two height-adjustable sliding pieces that are mounted on the Octopus Eco support frame. This extension enables the use of the OCC-RT01 radar reflector and OCD-RT02 lidar target. This means that the radar/lidar sensors can be calibrated on almost all cars, SUVs and vans. Suitable for the Octopus Eco.



■ **OCC-SLR** **OCTOPUS Laser swivel device with angle adjustment and foldable mirror**

Laser swivel device with angle adjustment and foldable mirror for easy alignment of the line laser (accessory item for the OCTOPUS Car ECO)



*quicklink to the product video*



■ **OCC-DT01**

**Double target  
VAG / Mazda / Mercedes for OCTOPUS Car**

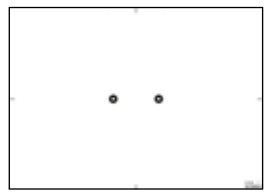
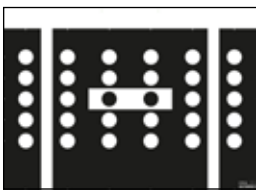

Double target VAG / Mazda / Mercedes for OCTOPUS Car

This accessory was designed for use with an OCTOPUS calibration device. Any other use represents improper use and is expressly at your own risk!

■ **OCC-DT02**

**Double target  
Nissan / Alfa Romeo for OCTOPUS Car**

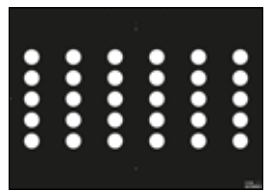
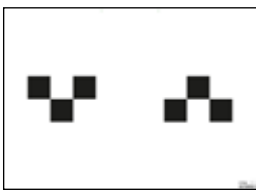

Double target Nissan / Alfa Romeo for OCTOPUS Car

This accessory was designed for use with an OCTOPUS calibration device. Any other use represents improper use and is expressly at your own risk!

■ **OCC-DT03**

**Double target  
Subaru / Hyundai for OCTOPUS Car**

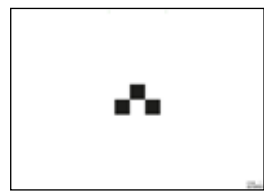
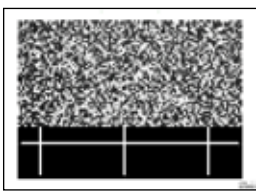

Double target Subaru / Hyundai for OCTOPUS Car

This accessory was designed for use with an OCTOPUS calibration device. Any other use represents improper use and is expressly at your own risk!

■ **OCC-DT04**

**Double target  
Honda / Mazda for OCTOPUS Car (in 2 parts)**

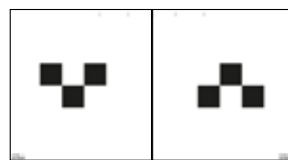
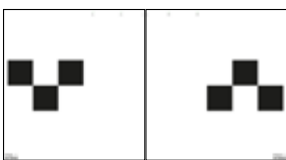

Double target Honda / Mazda for OCTOPUS Car (in 2 parts)

This accessory was designed for use with an OCTOPUS calibration device. Any other use represents improper use and is expressly at your own risk!

■ OCC-DT05

**Double target  
Toyota / Lexus for OCTOPUS Car**

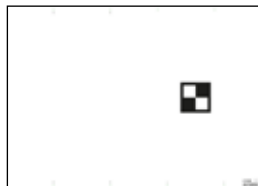
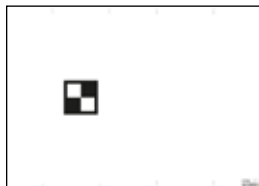

Double target Toyota / Lexus for OCTOPUS Car

This accessory was designed for use with an OCTOPUS calibration device. Any other use represents improper use and is expressly at your own risk!

■ OCC-DT06

**Double target  
Toyota / Lexus / Mitsubishi / Suzuki for OCTOPUS Car**

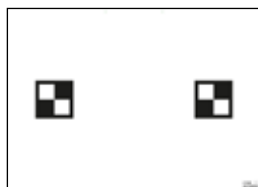
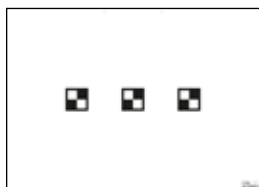

Double target Toyota / Lexus / Mitsubishi / Suzuki for OCTOPUS Car

This accessory was designed for use with an OCTOPUS calibration device. Any other use represents improper use and is expressly at your own risk!

■ OCC-DT07

**Double target  
Suzuki / Nissan for OCTOPUS Car**

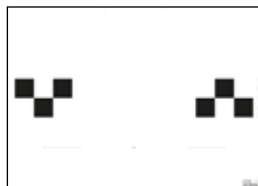
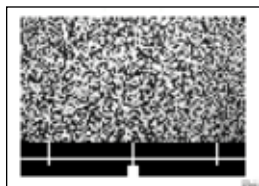

Double target Suzuki / Nissan for OCTOPUS Car

This accessory was designed for use with an OCTOPUS calibration device. Any other use represents improper use and is expressly at your own risk!

■ OCC-ET01

**Double target  
FCA / PSA / Opel / Kia / Hyundai / Renault / Smart  
for OCTOPUS Car ECO**

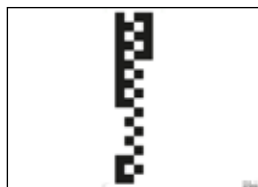

Double target FCA / PSA / Opel / Kia / Hyundai / Renault / Smart for OCTOPUS Car ECO

This accessory was designed for use with an OCTOPUS calibration device. Any other use represents improper use and is expressly at your own risk!



■ **OCC-ST01**

**Single target  
FCA / PSA / Opel / Kia / Hyundai for OCTOPUS Car**

Single target FCA / PSA / Opel / Kia / Hyundai for OCTOPUS Car

This accessory was designed for use with an OCTOPUS calibration device. Any other use represents improper use and is expressly at your own risk!

■ **OCC-ST02**

**Single target  
Renault / Smart for OCTOPUS Car**

Single target Renault / Smart for OCTOPUS Car

This accessory was designed for use with an OCTOPUS calibration device. Any other use represents improper use and is expressly at your own risk!



■ **OCC-ST03**

**Single target  
Honda for OCTOPUS Car**

Single target Honda for OCTOPUS Car

This accessory was designed for use with an OCTOPUS calibration device. Any other use represents improper use and is expressly at your own risk!



■ **OCT-ST01**

**Single target  
MAN / Scania for OCTOPUS Truck**

Single target MAN / Scania for OCTOPUS Truck

This accessory was designed for use with an OCTOPUS calibration device. Any other use represents improper use and is expressly at your own risk!



■ **OCT-ST02**

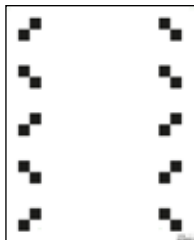

**Single target**  
**Volvo / Renault for OCTOPUS Truck**

Single target Volvo / Renault for OCTOPUS Truck

This accessory was designed for use with an OCTOPUS calibration device. Any other use represents improper use and is expressly at your own risk!

■ **OCC-KLL**



**Cross line laser**

Cross line laser with pulse mode, Precision of measure +/-2 mm -10m, Laser color red, Wave length 600-690 nM, Laser class II (2) , Laser range angle V130° - H150°, Certifications CE, RoHS, FDA, Class II, IEC60825-1:2014, IP 54, Pendulum angle max. +/- 4°

■ **LEM-4000**



**Laser Distance Meter**

Laser distance meter with high precision  $\pm 2\text{mm}$  for support calibration and other measuring process. Small and handy device with good over-view and easy handling.

■ **DNM-3050**



**Digital Inclinometer**

Digital Inclinometer to adjust or test the relative angle between surfaces.



■ **MWW-100-MW Milwaukee Minibox level**



Slight level with aluminum body, goes in every case or toolbox, robust acrylic level, shock-proof, and UV resistance. The precision of measurements is 0,029° (0,5 m)



■ **BMA-300-MW Pro-Compact Tape Measure 3 m**



Our Compact Tape Measures have up to 300 cm. These tapes are equipped with wear resistant nylon blade protection and an impact-resistant 5-point reinforced frame to withstand the jobsite. An integrated stamped steel belt clip allows you to easily carry the tape measure with you around the jobsite.



■ **BMA-500-MW Pro-Compact Tape Measure 5 m**



Our Compact Tape Measures have up to 500 cm. These tapes are equipped with wear resistant nylon blade protection and an impact-resistant 5-point reinforced frame to withstand the jobsite. An integrated stamped steel belt clip allows you to easily carry the tape measure with you around the jobsite.

### ■ TX-APP06.5-OB



### TEXA diagnostic software IDC5 Plus Car with interface Navigator TXT Multihub + 12 month updates and support

TEXA's IDC5 software is the ideal partner for our OCTOPUS calibration devices. Because just like the OCTOPUS, the IDC5 software can be used for both cars and trucks and covers a huge range of vehicles. Through specific diagnostic aids for each make and model, the diagnostic software provides the necessary information such as the target to be used, the correct height, the distance to the vehicle, etc. for the correct positioning of the calibration device and guides the user step by step through all phases of the adjustment. The diagnostic and calibration protocol can be saved in the customer administration or printed out directly for the customer. Thanks to TEXA Security Access with Authenticated Diagnosis, unlocking the Security Gateways (SGW) on modern vehicles is safe, official and simple - without the tedious and time-consuming registration with each with each individual vehicle manufacturer.

The new TXT Multihub vehicle interface has excellent connectivity and masters all current and future important protocols.

- WiFi module for diagnostic operations under CAN, CAN FD and DoIP
- Network connection (Ethernet) for DoIP (ISO 13400)
- USB connection for all types of diagnostics, incl. pass-thru (SAE J2534-1 and SAE J2534-2)
- Bluetooth interface for conventional diagnostics



### ■ TX-P12926

### TEXA diagnostic software IDC5 Plus Truck (integration) for installation on a PC

Extension of the diagnostic software IDC5 Plus Car by the truck module. Supplied as an electronic licence. Software only available as download.

■ **TX-APT06.6-OB**



**TEXA diagnostic software IDC5 Plus Truck with interface Navigator TXT Multihub + 12 month updates and support**

TEXA's IDC5 software is the ideal partner for our OCTOPUS calibration devices. Because just like the OCTOPUS, the IDC5 software can be used for both cars and trucks and covers a huge range of vehicles. Through specific diagnostic aids for each make and model, the diagnostic software provides the necessary information such as the target to be used, the correct height, the distance to the vehicle, etc. for the correct positioning of the calibration device and guides the user step by step through all phases of the adjustment. The diagnostic and calibration protocol can be saved in the customer administration or printed out directly for the customer. Thanks to TEXA Security Access with Authenticated Diagnosis, unlocking the Security Gateways (SGW) on modern vehicles is safe, official and simple - without the tedious and time-consuming registration with each with each individual vehicle manufacturer.

The new TXT Multihub vehicle interface has excellent connectivity and masters all current and future important protocols.

- WiFi module for diagnostic operations under CAN, CAN FD and DoIP
- Network connection (Ethernet) for DoIP (ISO 13400)
- USB connection for all types of diagnostics, incl. pass-thru (SAE J2534-1 and SAE J2534-2)
- Bluetooth interface for conventional diagnostics



■ **TX-P1291B**

**TEXA diagnostic software IDC5 Plus Car (integration) for installation on a PC**

Extension of the diagnostic software IDC5 Plus Truck by the Car module. Supplied as an electronic licence. Software only available as download.

### ■ GY-027510 **Booster 12V (600A)**



The NOMAD POWER PRO 700 is a lithium-based power pack. It combines 3 functions:

- Battery-Supplied jump start (Booster) for 12V vehicle (motorcycle, quad, car ect.)
- independent supply for all current electrical equipment (smartphone, tablet, computer ect.)
- Emergency lamp 2 x USB-Ports 5V, for charging smartphone, tablet, GPS ect.
- 1 x 15V (10A), ideal for camping, to supply a 12V electrical appliance (cool box, fan ect.)

### ■ GY-025967 **Charger with inverter technology 12/24V (100A)**



The GYSFLASH 101.24 CNT FV is a powerful inverter charger (100 A). It stabilizes the voltage of a 6 V, 12 V and 24 V lead-acid or lithium battery (lithium-ion "standard" + lithium-iron-phosphate) for vehicle diagnostics and provides optimal charging quality for the maintenance of batteries of the latest technology . The practical USB connection also offers the option of personalization and expansion.

4 operating modes:

- Charge: for 6, 12 or 24 V Lead or Lithium batteries from 5 to 1200 Ah.
- Diagnostic: supports up to 100 A for 12 V or 24 V batteries in vehicles in the diagnostic phase, in maintenance workshops.
- Showroom: provides power compensation when using the electrical accessories of a demonstration vehicle. It also manages the optimal charging of the battery.
- Tester: Allows you to check the battery voltage, evaluate the starting system (starter + battery) and the condition of the vehicle's alternator.

■ **GY-026971**



**Charger with inverter technology 12V (120A)**

The GYSFLASH 121.12 CNT FV is a powerful inverter charger (120 A). It stabilizes the voltage of a 12V lead-acid or lithium battery for vehicle diagnostics and provides optimal charging quality for the maintenance of batteries of the latest technology. The practical USB connection also offers the option of personalization and expansion.

4 operating modes:

- Charging: for 12 V, lead or lithium (LFP) batteries between 5 - 1500 Ah.
- Diagnostics: supports up to 120 A for 12 V batteries in vehicles during the diagnostic phase in maintenance workshops.
- Showroom: provides power compensation when using a demonstration vehicle's electrical accessories. It also controls the battery's optimal charging process.
- Tester: Tester: allows you to check the battery voltage and evaluate the starting system (starter and battery) as well as the condition of the vehicle's alternator.

■ **GY-029415**



**Charger with inverter technology 12V (100A)**

The Gysflash 100-12 HF is an inverter-based, stabilized voltage source with 5 main functions:

- Charging of starter batteries with a processor controlled charging curve
- Support of the 12 V on-board network during the diagnostic phase
- Securing the power supply for demonstration vehicles in the showroom
- Supply of the on-board network when the battery is changed to back up memory contents
- Use of the device as a stabilized voltage source with individually programmable voltage and current



**■ SK-1060K****ProGlass SK-1060K 1-Component PUR Auto Glass Adhesive cartridge at 310 ml**

ProGlass SK-1060K is a single-component auto glass adhesive with a short drive-away time which can be used during the whole year.

The adhesive is high-modulous, easy to applicate, it can be used for practically all vehicles and offers a safe drive-away time of only 1 hour (tested by TÜV).

With these features ProGlass SK-1060K is a true all-in-one product for automotive replacement glazing.

For further information please refer to the technical data sheet.

packaging unit:  
carton at 12 pieces incl. plastic nozzle

**■ SK-1060B****ProGlass SK-1060B 1-Component PUR Auto Glass Adhesive sachet at 400 ml**

ProGlass SK-1060B is a single-component auto glass adhesive with a short drive-away time which can be used during the whole year.

The adhesive is high-modulous, easy to applicate, it can be used for practically all vehicles and offers a safe drive-away time of only 1 hour (tested by TÜV).

With these features ProGlass SK-1060B is a true all-in-one product for automotive replacement glazing.

For further information please refer to the technical data sheet.

packaging unit:  
carton at 12 pieces incl. plastic nozzle and adaptor



■ **SP-1010**

**Adhesive Agent / All-in-One Primer  
bottle at 125 ml**

■ **SP-0010**

**Adhesive Agent / All-in-One Primer  
applicator-stick at 10 ml**



This all-in-one primer (black primer) is the perfect UV protection for our ProGlass PUR adhesive. But as a real universal talent the primer can also be applied on all other surfaces incl. the remaining PUR bead on the pinchweld and coatings on the new glass. No separate activator or transparent primer is necessary.

Additionally this all-in-one primer is an effective anticorrosive so that eventually occurring damages on the pinchweld can be simply covered with this primer (apply 2 layers).

14 days storage life after the first opening of the bottle!

The handy primer-stick is the clean solution for a one-time application. No laborious opening, no additional applicator needed.

For further information please refer to the technical data sheet.

Bottles can be used for 14 days from the first opening!

Primer sticks are single use, i.e. to consume immediately after opening.



■ **VRS-1000**

**ProGlass Pre-Cleaner  
can at 1,000 ml**

The pre-cleaner is meant for cleaning and degreasing of a new glass before applying the primer for the adhesive. The highly effective formulation does not only take off any adhesive tape residues and greasy contaminations but also **reliably removes silicone residues and flexibilizers** from foams and plastic foils that are commonly used to protect automotive glasses during transportation.

**■ SKS-1060K ProGlass Bonding Kit Cartridge**

Kit contains:

- 1 cartridge SK-1060K auto glass adhesive (310 ml)
- 1 applicator-stick SP-0010 All-In-One primer (10 ml)
- 1 plastic nozzle
- 1 product information / application note

**■ SKS-1060B ProGlass Bonding Kit Sachet**

Kit contains:

- 1 sachet SK-1060B auto glass adhesive (400 ml)
- 1 applicator-stick SP-0010 All-In-One primer (10 ml)
- 1 plastic nozzle and adaptor
- 1 product information / application note

### ■ KTO-230



#### **Cartridge Heater for 2 cartridges, 230V**

Powerful Cartridge Heater for warm-up two 310 ml cartridges. Guarantees an optimum processing of the PU during the cold season. Delivery without cartridges.

- Voltage: 230V
- Demand: up to 60° Degree
- Capacity: 2 x 310ml Cartridge
- Inside Dimension:  $\varnothing = 48$  mm L = 220 mm
- Weight: 1475 g

### ■ MHP-139



#### **Hot Pocket 12V / 230V for cartridge and sausage up to 400 ml**

Very spacious hot pocket with a capacity of 40 l perfect for mobile using in the cold season.

- Connection: 12V/230V
- Output: max. 40 degree
- Length: 495 mm
- Wide: 457 mm
- Height: 178 mm
- Material: Fabric
- Color: Red



- **KSP-1580-12** Plastic nozzles, package of 12, M15 x 1.5 x 82 mm
- **KSP-1580-100** Plastic nozzles, package of 100, M15 x 1.5 x 82 mm

Cartridge nozzles made of PE with embossed cutting marks, for 'cut to fit' use. For the application of auto glass adhesives in aluminium cartridges with standard thread M15 x 1.5. With separately available adaptor (item no. KBA-4915) also suitable for sachets.



- **KSP-15104-12** Cartridge Nozzle, M15 x 1,5 x 105 mm, package at 12 pieces
- **KSP-15104-100** Cartridge Nozzle, M15 x 1,5 x 105 mm, package at 100 pieces

- Cartridge nozzles made of PE for 'cut to fit' use
- Without cutting marks including flange
- For the application of auto glass adhesives in aluminium cartridges with standard thread M15 x 1.5

With separately available adaptor (item no. KBA-4915) also suitable for sachets.



- **KSP-1580S-12** Plastic nozzles, M15 x 1.5 (pre-cut), package of 12
- **KSP-1580S-100** Plastic nozzles, M15 x 1.5 (pre-cut), package of 100

Cartridge nozzles made of PE with pre-cut V-notch and guiding pin. For the application of auto glass adhesives in aluminium cartridges with standard thread M15 x 1.5. With separately available adaptor (item no. KBA-4915) also suitable for sachets.



- **KBA-4915-12** Adaptor for plastic nozzles M15 x 1.5, package of 12
- **KBA-4915-50** Adaptor for plastic nozzles M15 x 1.5, package of 50

Plastic adaptor made of PE for using auto glass adhesive in sachets with standard plastic nozzles with inside thread M15 x 1.5 mm.



■ **KSP-15105V-10** Cartridge Nozzle M15 x 1,5 x 105 mm,  
Package of 10 pieces

- Cartridge nozzles made of PE for 'cut to fit' use
- With cap against drying-out the material
- Without cutting marks including flange
- For the application adhesives in aluminium/plastic cartridges with standard thread M15 x 1.5



■ **KSP-15110D-10** Cartridge Nozzle 360° rotatable, M15 x 1,5, 'cut to fit' model,  
Package of 10 pieces

Cartridge nozzles 360° rotatable made of PE for 'cut to fit' use. For the application of auto glass adhesives in aluminium cartridges with standard thread M15 x 1.5. With separately available adaptor (ProGlass KBA-4915) also suitable for sachets.

Total length: 110 mm  
Angled: 85 mm



■ **KA-539** Cartridge Opener

A handy tool to remove the bottom seal (left side in the figure) of many aluminium cartridges as well as to open the front seal (right side in the figure) without making a mess.



■ **UTO-539** Cartridge Opener 2-fold  
for regular and wide nozzle openings

A handy tool to remove the bottom seal (left side in the figure) of many aluminium cartridges as well as to open the front seal (right side in the figure) without making a mess. The stem for the nozzle opening is stepped so that you can use it to open both common types of cartridges.



■ **KSZ-163**



**Nozzle Cutting Pliers, made of plastic**

For easy and tidy cutting a perfect V-notch for sealant application. Pliers made of fiber-reinforced plastic, blade made of aluminium with a millimeter scale.

These pliers cut a narrow and high V-notch which makes them perfect for the application of high-modulus adhesive material.

depth of cut (at a width of 7 mm): 22 mm



■ **KSZ-306**



**Nozzle Cutting Pliers, metal version**

Robust pliers for easy and tidy cutting a perfect V-notch for sealant application. Pliers made of metal, blade made of solid steel.

These pliers cut a classical wide V-notch. To apply a higher adhesive bead the nozzle opening must be cut to a bigger diameter.

depth of cut (at a width of 7 mm): 13 mm



■ **RKS-594**

**Nozzle Cutter**

To open plastic cartridges and to cut the nozzle without risk of injury.

■ **MK-081**

**Replacement Blades for RKS-594**

Package at 5 pieces



■ **KSK-050**

**2C adhesive with 50ml cartridge**

2C adhesive long term bonding for the most plastic parts. Fast repair or installation off the following materials: EPDM, PP, PUR, RIM, RRIM, SMC, TPO, TPE und Fibreglas. 2C cartridge with 50 ml adhesive.

- 50 ml 2C
- 30-50 second processing time
- Hand-tight after 90 seconds
- Can be sanded after 5 min.
- Paintable after 30 min.



■ **MD-085**

**Static Mixer (single-use) for KSK-050, single**

■ **MD-085-P**

**Static Mixer (single-use) for KSK-050, package of 10 pieces**

- Static disposable mixing nozzle off plastic
- For 50 ml 2K cartridge
- Constant high-grade mixing ratio
- Bayonet fitting
- Nozzle length 65 mm
- Total length 85 mm



■ **KTP-502K**

**Manual Caulking Gun 11:1 for 50 ml 2C cartridges**

- The trigger ratio 11:1 facilitates ejection of the 2K material
- For 50 ml 2C cartridge
- Solid construction

■ **GMK-300**



**ProGlass Glass/Metal Bonding Kit**

- high-tensile and fast-curing special adhesive for glass/metal bondings
- for the permanent bonding of rearview mirror plates made of metal to windcreens
- the 2-component superglue cures hand-tight within 30 seconds
- package content is sufficient for bonding approximately 200 mirror plates
- adhesive cures clear-transparent
- the bonding is resistant against humidity and high variation in temperature
- Note: Not suitable for light-alloy mirror stems (e.g. Ford). Danger of tension cracks!
- package contents: 15 ml adhesive, 15 ml activator

*quicklink to the product video*



■ **SFP-10**

■ **SFP-100**



**Mirror Adhesive Pads, package at 10 pieces**

**Mirror Adhesive Pads, package at 100 pieces**

Mirror adhesive pads of OEM quality for tension-free bonding of interior mirrors (e.g. Ford). The double-sided adhesive pad has a very high tack. Degrease glass and mirror base well, then press on the mirror strongly for a few seconds - ready!

dimensions: 41 x 28 x 1.0 mm



■ **RMS-105**

**Loctite Interior Mirror Bonding Kit  
for tension-free bondings**

Bonding kit for durable and tension-free bonding of all types of interior mirrors. Package contains 5 ml glue and 10 nylon squares (tintured with activator).

**■ LSS-085****Conductive Silver Pen, 8.5 g**

The conductive silver pen is suitable to metal-coat all smooth surfaces. This is a simple method to produce or repair electrically conductive connections. As this pen can also be used overhead it is especially suitable for the repair of defroster wires on a heated rear window.

**■ HP-1002****Fine Paint-Brush**

Paint-brush in size 2 (= very fine tip) for the application of conductive silver paint and wherever is a need for selective repairs.

**■ TVB-0333****Fine Line Tape blue, 3 mm wide, reel at 33 m**

The fine line tape is made of PVC as a masking tape for different workings. For example it is perfect to paste up a cutting line to facilitate the tailoring of window films. But you can also use it to easily paste up boundary lines when repairing the wires of a rear window heater.



■ **LSK-140**

**Conductive Silver Bonding Kit, 14 g**

2-component epoxy for making conductive bondings.

This adhesive can be used in all situations where soldering is difficult or impossible. Therefore it is just perfect to re-affix a broken electrical connection to a heated rear window.



■ **TPB-1910**

**Textile Protection Tape black  
19 mm wide, reel at 10 m**

■ **TPB-1925**

**Textile Protection Tape black  
19 mm wide, reel at 25 m**



The textile protection tape is a multi-purpose adhesive tape. It can be used e.g. to treat creaking linings, plastic parts or cables. It is also very suitable to wrap cable loops.



UP-100B

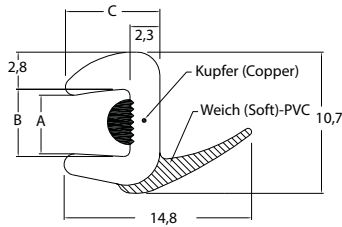

A = 4,5 mm ± 0,3 mm  
 B = 5,2 mm ± 0,3 mm  
 C = 7,5 mm ± 0,3 mm

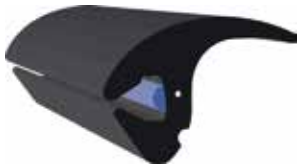

UP-105B

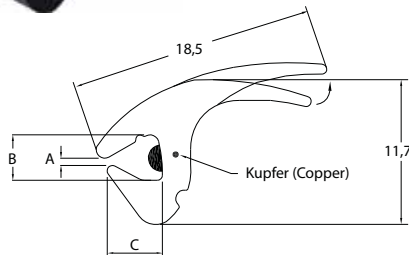

A = 2,5 mm ± 0,3 mm  
 B = 3,7 mm ± 0,3 mm  
 C = 4,5 mm ± 0,3 mm



UP-107B

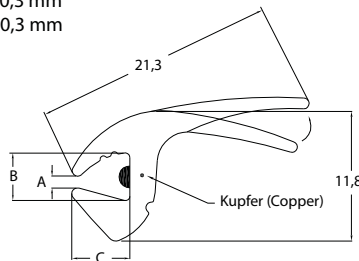

A = 2,5 mm ± 0,3 mm  
 B = 4,2 mm ± 0,3 mm  
 C = 5,1 mm ± 0,3 mm



UP-200

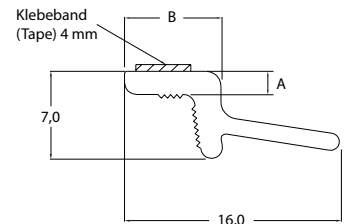

A = 1,7 mm ± 0,3 mm  
 B = 7,1 mm ± 0,3 mm

- **UP-100B**
- **UP-105B**
- **UP-107B**
- **UP-200**

**Universal-Moulding with Butyl Glue**  
 Type 'T4', reel at 23 m

**Universal-Moulding with Butyl Glue**  
 16 mm wide, reel at 23 m

**Universal-Moulding with Butyl Glue**  
 19 mm wide, reel at 23 m

**Universal Underside Moulding, self-adhesive**  
 Type 'VW', reel at 30 m

- With the universal mouldings, compared to model type mouldings, you are able to reduce storage space and at the same time, save a lot of money.
- Our universal mouldings are made of high-quality material and are easy to handle.
- Silk-matt surface for a perfect look
- Material particular flexible, for neatly fitting borders
- Mouldings are suitable for all LSG windscreens with a thickness of 4-6 mm
- For easier installation the glass channel has a thin layer of butyl glue (marked blue in the figure)
- Underside moulding UP-200 with strong adhesive tape (marked blue in the figure) for safe fixation on the glass
- The included metal filament (white spot in the figure / not for UP-200) avoids unintentional stretching of the moulding during the installation or shrinking over time



■ **MCA-265**

### **Standard Moulding Maker**

The standard moulding maker enables to mitre universal mouldings.

We recommend to stick the cuts with Loctite 4850 superglue.

Suitable replacement blade: TK-10 or TKS-100



■ **401**

### **Loctite 401 Superglue tube at 3 g in blister pack**

Loctite 401 is especially suitable for bonding rubber, plastic and metal as well as porous materials like polyurethane foam many vehicle mouldings are made of. This cyanoacrylate glue dries within seconds and forms a transparent, hard layer. It is therefore not applicable for flexible bondings.



■ **4850**

### **Loctite 4850 Superglue tube at 5 g in blister pack**

Loctite 4850 stays flexible after drying and is particularly applicable for bonding elastomers and rubbers as well as many types of plastic, metal and porous materials. This cyanoacrylate glue dries within seconds and forms a transparent and flexible bonding.



- **TMB-5555-3** **Sponge Rubber Tape (Neoprene) 5 x 5 mm self-adhesive, 3 reels at 5.5 m**
- **TMB-5555-P** **Sponge Rubber Tape (Neoprene) 5 x 5 mm self-adhesive, 12 reels at 5.5 m**
- **TMB-6655-3** **Sponge Rubber Tape (Neoprene) 6 x 6 mm self-adhesive, 3 reels at 5.5 m**
- **TMB-6655-P** **Sponge Rubber Tape (Neoprene) 6 x 6 mm self-adhesive, 12 reels at 5.5 m**

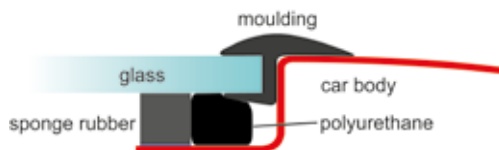

Sponge Rubber Tapes are mandatory for many Asian cars and work as a spacer between car body and windscreen. At the same time they make a nice view from inside.

The high-quality neoprene sponge has a high density (small pores) and a rich dark colour.



- **TMC-5545-3** **Sponge Rubber Tape (PE) 5 x 5 mm self-adhesive, 3 reels at 4.5 m**
- **TMC-5545-P** **Sponge Rubber Tape (PE) 5 x 5 mm self-adhesive, 12 reels at 4.5 m**
- **TMC-6645-3** **Sponge Rubber Tape (PE) 6 x 6 mm self-adhesive, 3 reels at 4.5 m**
- **TMC-6645-P** **Sponge Rubber Tape (PE) 6 x 6 mm self-adhesive, 12 reels at 4.5 m**

The polyethylene (PE) sponge rubber tapes are used in the same way than the higher grade neoprene tapes.

The difference is the lower density of the PE sponge (bigger pores) and the lighter colour which is more like a dark grey than black.



■ **TMA-2010**

**Sponge Rubber Tape 20 x 12 mm self-adhesive (compressed), reel at 10 m**

This tape matches with the originally used sound-absorbing foam tapes between windscreen and dashboard. Therefore this endless foam tape on reel is ideal to replace the vehicle-specific sealing tapes, especially for all BMW series (1 series from 2004, 2 series from 2014, 3 series from 2005, 4 series from 2013, 5 series from 2003, 6 series from 2011, 7 series from 2008), various Audi series (A6 from 2011, A7 from 2010, A8 from 2004), as well as different Renault models (e. g. Espace, Mégane, Scénic).

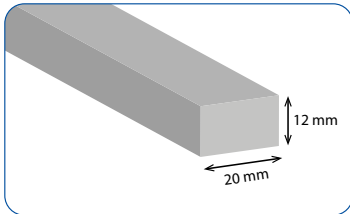

Due to its good acoustic properties (reduction of low-frequency vibrations) it makes sense to use this self-adhesive, slowly expanding foam tape also on many more vehicles for sound insulation purposes.

Delivery pre-compressed, that is to say that the height on the reel is only about 2 mm. After unreeling/applying the tape will expand very slowly and reaches its total height of 12 mm only after approx. 30 minutes. The windscreen shall be fitted directly after applying the tape, so that the windscreen adhesive has gained enough stability when the tape has expanded completely.



- **TAC-1210** Acrylic Tape transparent, 12 mm wide reel at 10 m
- **TAC-1910** Acrylic Tape transparent, 19 mm wide reel at 10 m
- **TAC-2510** Acrylic Tape transparent, 25 mm wide reel at 10 m
- **TAC-5005** Acrylic Tape transparent, 50 mm wide reel at 5 m

The entirely transparent adhesive tape is 1.0 mm thick and has an extraordinary high tack, also under high temperatures. It is virtually invisible! Most suitable for glass bondings if unobtrusive look is desired, e.g. for antennas and sensors.



- **TAT-1910** Acrylic Tape black, 19 mm wide extra thin 0.25 mm, reel at 10 m

The tape finds his application where is needed a very high adhesiveness but a very low interspace between the two glued parts.



- **TPC-1910** PET Tape transparent, 19 mm wide extra thin 0.2 mm, reel at 10 m

The tape finds his application where is needed a very high adhesiveness but a very low interspace between the two glued parts.



- **TAB-0610** Acrylic Tape black, 6 mm wide reel at 10 m
- **TAB-0910** Acrylic Tape black, 9 mm wide reel at 10 m
- **TAB-1210** Acrylic Tape black, 12 mm wide reel at 10 m
- **TAB-1910** Acrylic Tape black, 19 mm wide reel at 10 m
- **TAB-2510** Acrylic Tape black, 25 mm wide reel at 10 m
- **TAB-5005** Acrylic Tape black, 50 mm wide reel at 5 m

The deep black double-sided adhesive tape is 1.1 mm thick and has an extraordinary high tack, also under high temperatures. It is suitable to bond e.g. antennas on glass, to fix trims and emblems or to attach linings.



- **TF-0910** Polyethylene Tape dark-grey, 9 mm wide reel at 10 m
- **TF-1210** Polyethylene Tape dark-grey, 12 mm wide reel at 10 m
- **TF-1910** Polyethylene Tape dark-grey, 19 mm wide reel at 10 m
- **TF-2510** Polyethylene Tape dark-grey, 25 mm wide reel at 10 m

The dark-grey double-sided adhesive tape is 0.95 mm thick. It has very good final strength and is especially low-priced. It is most suitable to fix trims and for all other workings which use a lot of tape.



■ **TPO-3833**

**Fixing Tape orange, perforated, 38 mm wide reel at 33 m**

■ **TPO-7691**

**Fixing Tape orange, perforated, 76 mm wide reel at 91 m**

Especially designed to fix trims, to keep freshly bonded glasses from sliding and to mask the corners of a glass during storage and transport to prevent scratching. Thanks to the perforation (every 15 cm) this tape is very easy to portion from the reel.

The most important thing hereby is: This tape is removable without any residue and it does not corrode the surface of e.g. varnish, rubber or plastic.



■ **MTP-3850**

**Premium Paper Masking Tape 38 mm wide reel at 50 m**

High-grade paper masking tape with a special adhesive film - even after several days of application it does not leave any residue on a vehicle's paintwork, rubber and plastic parts. Due to the high stability (does not elongate noticeable) it is ideal to secure freshly bonded windcreens against sliding. Thanks to the paper carrier the tape can be sectioned very easily and is though very strong.



■ **MTG-5050**

**Paper Masking Tape yellow, 50 mm wide reel at 50 m**

Simple paper masking tape. Good stability (does not elongate easily) and therefore also suitable to secure freshly bonded windcreens against sliding. In short-term use this tape usually can be removed without residues and does not corrode the surface of e.g. varnish, rubber or plastic.

**NOTE:** In long-term use or when exposed to direct sunlight this tape can leave residues on the vehicle's varnish.



■ **STG-3850**

**Woven Adhesive Tape black, 38 mm wide  
reel at 50 m**

■ **STG-5050**

**Woven Adhesive Tape black, 50 mm wide  
reel at 50 m**

Very densely woven and strong adhesive tape to mask and protect all sensitive areas such as mudguard, bonnet edge, A-pillar and roof edge, while cutting out a glass with wires or hand knives. In short-term use this tape usually can be removed without residues and does not corrode the surface of e.g. varnish, rubber or plastic.

**NOTE:**

In long-term use or when exposed to direct sunlight this tape can leave residues on the vehicle's varnish.



■ **GTG-5050**

**Woven Adhesive Tape grey, 50 mm wide  
reel at 50 m**

Very densely woven and strong adhesive tape to mask and protect all sensitive areas such as mudguard, bonnet edge, A-pillar and roof edge, while cutting out a glass with wires or hand knives. In short-term use this tape usually can be removed without residues and does not corrode the surface of e.g. varnish, rubber or plastic.

**NOTE:**

In long-term use or when exposed to direct sunlight this tape can leave residues on the vehicle's varnish.



■ **ATG-5050**

**Woven Adhesive Tape silver, 50 mm wide  
reel at 50 m**

Strong woven adhesive tape to secure freshly bonded windscreens against sliding and for common jobs.

**NOTE:**

In long-term use or when exposed to direct sunlight this tape can leave residues on the vehicle's varnish.

■ **KRS-1588**

**Eraser Disk Ø 88 mm x 15 mm  
to remove glue residues**

With this eraser disk all residues of adhesives can be removed without effort from car varnish or other surfaces. Just insert it to the cordless drill and erase the glue residues.



■ **TB-3006**

**Butyl Tape Ø 3 mm, reel at 6 m**

■ **TB-3010**

**Butyl Tape Ø 10 mm, reel at 4.5 m**

The thin butyl cord is e.g. excellent for gluing decorative frames before inserting the glass or protruding seals after assembly. The thick cord is great for sealing and grouting on mobile homes, trucks, buses, trains, etc.



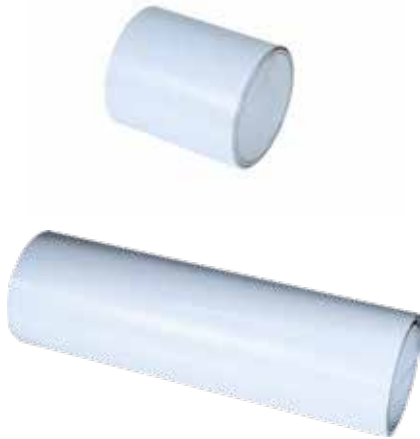

■ **SFT-1025**

**Clear Protective Film, 100 mm wide reel at 2.5 m**

■ **SFT-1525**

**Clear Protective Film, 150 mm wide reel at 2.5 m**

■ **SFT-2025**

**Clear Protective Film, 200 mm wide reel at 2.5 m**

■ **SFT-2525**

**Clear Protective Film, 250 mm wide reel at 2.5 m**

■ **SFT-3025**

**Clear Protective Film, 300 mm wide reel at 2.5 m**

The self-adhesive clear polyurethane foil has a smooth and glossy surface. It has been developed as a stone-chipping protection for painted car body parts. Thanks to the extreme elongation the film can be applied wrinkle-free to strongly curved parts, e. g. like the housing of a side mirror.

All painted surfaces like fenders, hoods or side mirrors can be protected against stone-chipping by applying this almost invisible film.

Technical data:

- film thickness: 200 µm
- elongation: 700 %
- temperature resistance: -40 to +120°C
- durability: 7-10 years
- delivery form: 2.5 m on cardboard reel (inside-Ø 76 mm)



■ **SFS-1550**

**Black Protective Film, 150 mm wide reel at 5 m**

This self-adhesive black protective foil has a medium structured surface. It is suited for covering B-pillars or door frames, as a stone-guard body protection or to protect the trunk sill.

Technical data:

- film thickness: 150 µm
- temperature resistance: -40 to +90°C
- durability: 7-10 years
- delivery form: 5 m on cardboard reel (inside-Ø 76 mm)





■ **PES-2500**

**PE Protection Foil, self-adhesive, 82 cm wide reel at 25 m**

■ **PES-0165**

**PE Protection Foil, self-adhesive, 82 cm wide reel at 1.65 m, for one application**



This foil is a temporarily substitute for damaged side or rear windows, to keep the vehicle mobile. The small reel is ideal to replace a toughened safety glass window and should always stay in your vehicle.

The self-adhesive, transparent PE foil (film thickness: 130 µm = 0.13 mm) is easy to attach. The bonding film is very strong and allows tight stretching when fixing. This reduces driving noise to a minimum. Crinkle-free mounting assures that the vehicle will stand even a heavier rain shower.

**TIP:** Due to the strong bonding film this foil should only be applied on varnishes that are in good condition. In doubt it is recommended to re-condition the area with a polishing compound. For removal you should warm up the film with a hot air gun - this will reduce the glue residues (possible residues can be removed with the eraser disc KRS-1588).



■ **PMS-3000**

**Window Guard™ PE Protection Foil, self-adhesive, all 91.5 cm perforated, 91 cm wide, reel at 30 m**

The protection foil is a temporarily substitute for damaged side or rear windows and keeps your vehicle mobile that way.

Window Guard™ is a self-adhesive, clear PE foil (film thickness: 83 µm = 0.083 mm) with a high level of transparency. Due to the perforation it is especially easy to attach. The bonding film is very strong and allows tight stretching when fixing. This reduces driving noise to a minimum. Crinkle-free mounting assures that the vehicle will stand even a heavier rain shower.

**TIP:** Due to the strong bonding film this foil should only be applied on varnishes that are in good condition. In doubt it is recommended to re-condition the area with a polishing compound. For removal you should warm up the film with a hot air gun - this will reduce the glue residues (possible residues can be removed with the eraser disc KRS-1588).



10

Other Hand Tools

10

Other Hand Tools



■ **SLP-101**

**Rope Insert Tool for passenger vehicles  
tube outside-Ø: 6 mm, rope length: 6 m**

An indispensable tool for the replacement of glasses that are installed with a rubber gasket. With the curved tube you easily place the rope in the channel of the rubber profile. Thanks to the ergonomically shaped handle the rope does not carve into your fingers while installing the rubber moulded glass.

■ **SLP-101-01**

**Replacement Rope 6 m for Rope Insert Tool SLP-101**

Very flexible and high-tensile rope made of fine nylon netting.



■ **SLN-102**

**Rope Insert Tool for commercial vehicles  
tube outside-Ø: 8 mm, rope length: 9 m**

An indispensable tool for the replacement of glasses that are installed with a rubber gasket. With the curved tube you easily place the rope in the channel of the rubber profile. Thanks to the ergonomically shaped handle the rope does not carve into your fingers while installing the rubber moulded glass.



■ **SLN-102-01**

**Replacement Rope 9 m for Rope Insert Tool SLN-102**

Very flexible and high-tensile rope made of fine nylon netting.





■ **LT-750**

**Locking Strip Tool with 2 double end tips**

General purpose tool with two double end tips = four different sized eyelets. Tips are fixed with a big knurled head screw and so no additional tool is required for turning and exchanging the tips. Suitable for locking strips of approx. 6 - 15 mm width.

■ **LT-750-1**

**Replacement Eyelet Set (2 pieces) for LT-750**

Inner dimensions of the eyelets:

7.5 (14.5) mm / 13.5 mm / 11.0 mm / 16.0 mm



■ **LT-415**

**Locking Strip Tool with interchangeable eyelets**

With this locking strip tool you can install all locking strips with a width from 8 - 19 mm. All eyelets can also be combined with the roller wheel (installed on the picture) to easily install locking strips.



■ **LT-415-1**

**Replacement Eyelet Set (5 pieces) for LT-415**

Inner dimensions of the eyelets:

9.5 mm / 10.5 mm / 11.5 mm / 12.5 mm / 13.5 mm

material thickness: 2.0 mm



■ **GHS-140**

**Pointed Hook, with short shaft**

total length: 200 mm



■ **GHS-280**

**Pointed Hook, with long shaft**

total length: 280 mm



■ **GHK-140**

**Ball-Tipped Hook, with short shaft**

ball-Ø: 4.5 mm

total length: 200 mm



■ **GHK-280**

**Ball-Tipped Hook, with long shaft**

ball-Ø: 5.0 mm

total length: 280 mm



■ GH-738

**Pointed Hook, special shape „U“**

The tridimensionally bent hook is great for working on rubber moulded glasses and for dismantling plastic panels.

total length: 210 mm



■ GH-749

**Pointed Hook, special shape „V“**

The tridimensionally bent hook is great for working on rubber moulded glasses and for dismantling plastic panels.

total length: 210 mm



■ GH-753

**Pointed Hook, special shape „L“**

The double bent hook is great to leverage a rubber profile over the pinchweld's edge.

total length: 190 mm





■ **GBZ-200**

**Glass Breaking Pliers 200 mm long  
jaw width approx. 25 mm**



■ **GBZ-225**

**Glass Breaking Pliers 225 mm long  
jaw width approx. 25 mm**



■ **GC-130**

**Glass Cutter, full metal version  
130 mm long**

- straight edge stand-off distance 1.8 mm
- cutting angle 120°



■ **GCK-119**

**Glass Cutter with rounded handle  
119 mm long**

- straight edge stand-off distance 2.0 mm
- cutting angle 135°



■ **GCM-130**

**Glass Cutter with turnable head  
130 mm long**

- straight edge stand-off distance 2.5 mm
- cutting angle 135°
- wooden handle



■ **DSP-120** Diamond Sanding Pad, black grit 120



■ **DSP-200** Diamond Sanding Pad, red grit 200

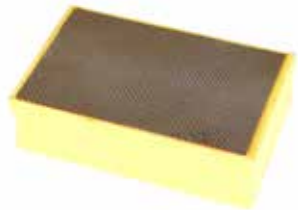

■ **DSP-400** Diamond Sanding Pad, yellow grit 400

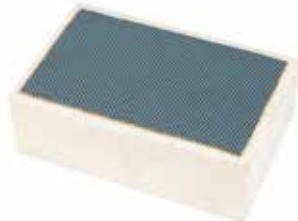

■ **DSP-800** Diamond Sanding Pad, white grit 800



■ **DSP-1000** Diamond Sanding Pad, blue grit 1000

These handy foam blocks are coated with a flexible diamond sanding surface on one side.

The sanding pads are perfect for grinding small damages and irregularities on glass edges (NOTE: Please only grind the glass edges and never the glass surface!). Moreover they will work on all hard material, but also on many soft surfaces. Even rubber and plastic parts can be burred clean and easy.





- **KM-130**
- **KM-140**
- **KM-150**

**Putty Knife 30 mm wide, with solid wooden handle**

**Putty Knife 40 mm wide, with solid wooden handle**

**Putty Knife 50 mm wide, with solid wooden handle**

These putty knives have a flexible steel blade with a big wooden handle and are very suitable to produce sealing joints on commercial vehicles, as well as other jointing work.

blade length: 110 mm

total length: 220 mm



- **KM-9527**

**Glazing Knife, straight shape**

Glazing knife with wooden handle for glazing and jointing work.

blade length: 95 mm

blade width: 27 mm



- **FTL-430**
- **FTL-430-1**

**LED Torch with flexible shaft**

**Replacement Bulb for FTL-430**

Requires three 1.5 V Lady batteries (not included).



- **FTL-402**
- **FTL-402-1**

**Mini Torch with flexible shaft**

**Replacement Bulb for FTL-402**

The torch comes with a small removable magnet tip. This makes it easy to find and pick up lost screws in a vehicle. Requires two 1.5 V AA batteries (not included).



- **PLE-160**

**LED Penlight**

- Very handy and bright LED lamp with two magnet inside
- Shock-Proof aluminium body
- Weatherproof
- Turnable clip with a 120 degree swivel range
- Perfect for workshop and handcraft



- **LED-LIGHT**

**LED Penlight**

- Very lightness and handy LED Flashlight
- Sturdy aluminium body
- Weatherproof
- Perfect for garage and trade

■ WSL-180



**LED Workshop Hand Lamp**

- Very bright LED Light with two lamp and one magnet inside
- Handy and solid plastic body included a LED
- Turnable head included 4 LED with a 90 degree swivel range
- Adjustable Stand with a 180 degree swivel range
- Weatherproof IPX4
- Perfect for workshop and handcraft

■ SLL-100



**LED Headlamp**

- Very bright LED lamp with two modi (Steady Light 3 Step/Sensor 1 Step)
- Rechargeable Li-Ion Battery(charging cable included)
- Shock-Proof plastic body
- Turnable body with a 60 degree swivel range
- Weatherproof IPX4
- Perfect for workshop and handcraft

■ ANL-400-MW **Battery Neck Light**



This rechargeable neck light provides 400 lumens of TRUEVIEW™ and over 8 hours of run-time to keep you working all day. 2 mode options allow you to manage output and run-time, plus a battery gauge in the power button will always inform you how much power you have left before a recharge is needed. The Neck Light has 130° of vertical light head rotation for easy positioning and an ergonomic, sweat-resistant band for your comfort. IP54 ingress protection against dust and water, chemical resistance to harsh chemicals found on site or in the shop, and a drop rating of 6ft.

■ PL-140



**LED Penlight**

Ball-pen shaped LED torch with very bright LED. Made of painted tin and plastics. Requires two 1.5 V AAA batteries (**included**).



■ **MSK-356**

**Magnet Bowl for small parts Ø 150 mm**

The bowl can be placed almost everywhere on a vehicle because the bottom has a rubber cover to avoid scratches. The strong magnet surely holds the bowl itself and all magnetic contents.



■ **MH-120**

**Telescopic Magnet**

The telescopic magnet is a real multi-purpose tool. The extremely strong magnet is capable to lift and carry weights up to 1.5 kg! Extendable from 12 - 60 cm.



■ **MHF-510**

**Magnetic lifter, flexible, 510 mm long**

Magnetic lifter with flexible shaft for difficult and bad visible application.



■ **FGR-440**

**Flexible Grabber**

Flexible Grabber with four claws for picking up small parts from difficult to reach areas.

Length 60 cm, max. opening of claws ca. 20 mm.



■ **TSP-2550**

#### **Telescopic Mirror 25 x 50 mm**

Small longish telescopic mirror with a clip to carry it in your shirt pocket, extendable from 11 - 44 cm.



■ **TSP-5050**

#### **Telescopic Mirror Ø 50 mm**

Big round telescopic mirror, extendable from 18 - 32 cm.



■ **ALS-185**

#### **All-Purpose Cutter, 185 mm long**

The handy formed All-Purpose Cutter allow trough his very smooth serrated blade a exactly and easy cut for the following material: Rubber, Plastic, Cardboard, Paper, Leather, Cable up to 2.0 mm, Wire up to 2.0 mm, Metal Sheet up to 0.8 mm and much more. Solid approved long-living construction.

Cutting length: 45 mm





■ **KSC-019**

**Plastic Scraper, 19 mm wide**

■ **KSC-025**

**Plastic Scraper, 25 mm wide**

Sturdy fiber-reinforced scrapers for the removal of bonded rails and badges.



■ **KSK-4510**

**Plastic wedges  
set of 2 pieces**

Perfect to wedge on the windscreen during the cut out process. For fixing door panes during removal and installation.

The plastic wedges are made of an impact-resistant material.

length 10 cm, width 4.5 cm, height 2.3 cm



■ **KSK-29190**

**Plastic wedge 190 x 29 x 24 mm**

Perfect to wedge on the Windscreen during the cut out process even to straighten from fender, car door or to spread any kind of opening. Also usable for all work on molding, cover, door panel, rubber etcetera. Because of the shock-resistant and special plastic become all surface of the attachment and covering preserve.



■ **RH-727**

**Rolling Work Seat 45 x 33.5 x 25 cm**

Solid rolling work seat with three open compartments and one subdivided compartment under the lid. With four robust swivelling castors made of plastic (caster Ø: 50 mm).

- load capacity: 110 kg
- very good manoeuvrability thanks to the 360° swivelling casters
- practical compartments for tools and small parts
- for convenient working on door glasses
- also perfect for headlight restoration
- allows a knee- and back-friendly work position



■ **RHR-410**

**Stepstool, approx. 41 cm high, made of plastic**

- Plastic stepstool with spring loaded castors that retract when weight is applied.
- Tolerates heavy use without losing its look.
- dent-proof, scratch-proof, rust-proof
- Capacity: 150 kg





■ RT-560

**Wheel Step Ladder**  
load capacity: 225 kg

- facilitates working on high vehicles
- simply put it over the front wheel, if necessary swivel in from the front
- applicable for almost all saloon cars, vans, SUVs and allterrain vehicles with a wheel diameter of at least 600 mm

**Note:** Due to the size of the wheel arch and the construction of the suspension strut not suitable for all vehicles



■ ULF-481

**Ultrasonic Leak Detector**

The ultrasonic leak detector makes it easy to find leak points quickly and reliably, e. g. on bonded glasses. The set includes an ultrasonic transmitter, a receiver and headphones. Requires two 9 V batteries (not included).

**Note:**

This device is operating with ultrasonic waves. Even smallest leaks can be indicated very reliably. But leaks on bonded vehicle glazings can only be found on dry vehicles! If the vehicle to test is wet you must first let it dry completely before you can use this leak detector to identify a leak on the adhesive bead. Also the glasses edge respectively the pinchweld must not be covered by any trims and mouldings. These parts will also hinder the ultrasonic waves and make it therefore impossible to find any leaks underneath.





■ **WSA-620**

**Auto Glass Tool Cart, fully equipped**



High-grade tool cart made of aluminium, plastics and coated steel plate. 4 swivel castors, thereof 2 with brake. 360° swivelmounted glass rack with 4 rubber cups for preparing glasses (item WSH-7050). The three top drawers are fully equipped with all hand tools needed to replace bonded and non-bonded glasses. And to keep everything in a nice order each tool has its own space in a rigid-foam lining. The three lower drawers without lining offer enough space for power tools or other big tools. In one of the high drawers for example we have put in the pair of suction lifters. To protect your tools all drawers can be locked with a central lock.

A paper roll holder (item PRH-380), a rod to hang the spray bottles, a 10 litre waste bin (item WAB-909) and two boxes for small parts such as clips and/or cans (items WKB-300 and WKB-400) are furthermore included.

item no.	description	item no.	description	item no.	description
PLE-160	LED Penlight	MH-140-WSP	Mini Hook 140 mm	SC-320	Scraper Blades 20 mm
MH-120	Telescopic Magnet	TS-135	ProGlass cutting Line TS	KFP-050	Pinchwelt Cleaning Brush
ZAW-090	Wiper Arm Puller, universal	P8	Spider cutting line P8	ALS-185	All-Purpose Cutter 185 mm long
HWA-2636	Wiper Arm Puller „EasyLift II“	WRD-LD	Line & wire dispenser	KSZ-163	Nozzle Cutting Pliers, made of plastic
WAV-899	Wiper puller Volkswagen Group	DST-757-WSP	Cutting Line Threader	FSC-150	ProGlass Pinchwelt Scraper
EWA-1702	Wiper Arm Puller, EasyLift	DBP-1824-WSP	Dashboard Protector 230 x 240 mm	GS-380	Glass Scraper with plastic handle
GHS-140	Pointed Hook, with short shaft	DBP-3316-WSP	Dashboard Protector 330 x 160 mm	MS-180	Installation Stick Round/Flat
GHS-280	Pointed Hook, with long shaft	DBP-4024-WSP	Dashboard Protector 400 x 240 mm	MS-181	Installation Stick Round/Round
CE-119	Clip Remover, flat/narrow	SB-886	Safety Goggles	OL-40	Olfa® Knife for 9 mm wide blades
MSL-265	Installation Lever flat/clip	ZMQ-425	Pull Knife with quick release system	AB-10	Olfa® Snap-Off Blades, 9 mm wide
CEK-215	Clip & Strip Remover	UWG-3	UltraWiz Serrated Blade Assortment	MSK-356	Magnet Bowl for small parts
CEK-180	Clip & Strip Remover	KS-125	Body Filler Applicators in 3 parts	PSL-150-1	2-Cup Suction Lifter (2 pieces)
LHK-160	Trim Jack	KA-539	Cartridge Opener	WSH-7050	Glass Rack
MS-205	Installation Stick Pointed/Round	SRB-12	Pinchwelt scraper blade, 12 mm wide	PRH-380	Paper Roll Holder for tool cart
MHS-068	Hook and Pick Set	SRB-17	Pinchwelt scraper blade, 17 mm wide	WAB-909	Waste Bin for tool cart
STS-039	Socket Set 1/4 drive in 39 parts	RK-100A	Scraper Blades 40 mm wide	WKB-300	Accessory Box for tool cart
WSP-003K-SO	Cutting Tool SPIDER 3 (tool only)	SPZ-160	Pointed Pliers with wire cutter	WKB-400	Accessory Box for tool cart
AS-115-K	Anchor Suction Cup Ø 115 mm (plastic)	SC-313	Scraper Blades 12 mm	WSA-600-0	Auto Glass Tool Cart, empty
MS-180-WSP	Cutting line install tool	SC-316	Scraper Blades 16 mm		



■ **WSA-600-0**

**Tool Cart, empty**

**Dimensions ca. (LxWxH): 800 x 450 x 985 mm**

High-grade tool cart made of aluminium, plastics and coated steel plate. 4 swivel castors, thereof 2 with brake, four drawers with a height of ca. 55 mm and two big drawers with a height of ca. 125 mm. All drawers are 100% useable and can be locked with a central lock to protect your tools.

On the left side it has a rack to hang spray bottles, on the right side it has a grill to hook in boxes for small parts or other things.



■ **WSH-7050**



**Glass Rack**

The glass rack transforms the tool cart WSA-600-0 into an auto glass work centre. The rack can be swivelled by 360°. If required you can take it off the screw-mounted base very easily.

Dimensions incl. base and rubber plates (LxWxH): 98.5 x 60.0 x 16.0 cm  
carrying capacity (if mounted on WSA-600-0): 60 kg

■ **PRH-380**



**Paper Roll Holder  
for tool cart WSA-600-0**

Made of black powder coated metal tube. Max. roll diameter 34 cm, max. roll width 41 cm. Delivered incl. mounting parts.

■ **WAB-909**



**Waste Bin  
for tool cart WSA-600-0**

Plastic waste bin to hang-on, capacity 10 l.

■ **WKB-300**

**Accessory Box for tool cart WSA-600-0  
305 x 80 x 82 mm**

■ **WKB-400**

**Accessory Box for tool cart WSA-600-0  
402 x 100 x 100 mm**



## ■ WSK-31

### Tool Case with 31 tools

High-quality and robust tool case made of plastic. Equipped with all tools needed to exchange a bonded windscreen. With this case you are ready to go! The two perfectly cut foam linings are good to keep track of your tools. Every single piece has a tidy place. So you have your tools always at your fingertips and nothing disappears.

Kit contains:

- 1 SD-22 ProGlass sawing wire, braided, spool at 22 m
- 1 VKD-22 ProGlass cutting wire, squared, spool at 22 m
- 1 DGL-200 wire handles, self-locking (pair)
- 1 DHL-300 wire guide, long version
- 1 DST-733 T-handle wire threader, large
- 1 SPZ-160 pointed pliers with wire cutter
- 1 ZMX-400 quick release pull knife
- 1 UWG-3 UltraWiz Serrated Blade Assortment, in 3 parts
- 1 GS-380 glass scraper
- 1 RK-100A scraper blades 40 mm wide (package at 100 pieces)
- 1 FSC-150 ProGlass scraper, with quick change system
- 1 SC-313 scraper blades 12 mm, package at 10 pieces
- 1 SC-316 scraper blades 16 mm, package at 10 pieces
- 1 SC-320 scraper blades 20 mm, package at 10 pieces
- 1 XL-2 Olfa long knife
- 1 LB-10 Olfa snap-off blades, package at 10 pieces
- 1 MS-180 installation stick round/flat
- 1 LH-230 trim jack
- 1 CEG-148 clip remover, wide
- 1 GHS-280 pointed hook, with long shaft
- 1 GHS-140 pointed hook, with short shaft
- 2 PSH-120-1 ProGlass 2-cup suction lifter, single
- 2 FIX-080 moulding clamp, single
- 1 SHX-110 knitted gloves, size XL
- 1 SB-886 safety goggles
- 1 STS-039 socket set 1/4" drive in 39 parts
- 1 ZAW-090 wiper arm puller, universal
- 1 KSZ-163 V-notch pliers
- 1 KA-539 cartridge opener



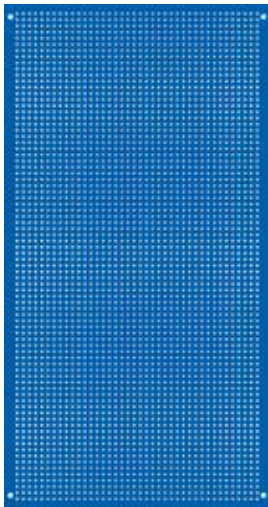

■ **IND-0609**

**INDECO Perforated Tool Board  
960 x 480 mm, blue**

INDECO tool board made of 1.5 mm perforated steel sheet. The boards are powder-coated and therefore very sturdy and durable. Due to a fine matrix of holes (12 x 12 mm hole spacing, 4.2 mm hole diameter) the board can be arranged individually.



■ **IND-601796**

**INDECO Screw, single**

Each holder requires two screws. Do not forget to order, because commonly available screws are too long.

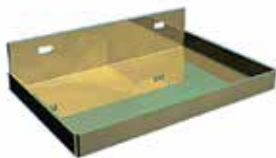

■ **IND-601099**

**Shelf, 250 x 100 x 15 mm**

Solid shelf for small parts and tins or bottles. Made of yellow galvanized sheet steel.

■ **IND-601201**

**Shelf 480 x 90 x 95 mm**

Solid shelf for tins or bottles. Made of electroplated steel panel.



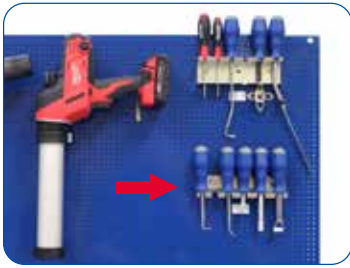

■ **IND-602030** **Toolholder 200 x 56 mm**

Sturdy tool holder made of yellow galvanized sheet steel.

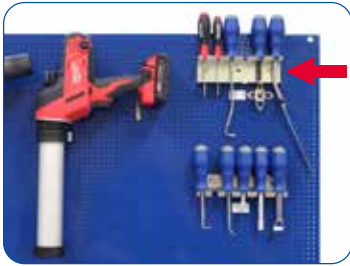

■ **IND-602060** **Toolholder 189 x 60 mm**

Sturdy tool holder made of yellow galvanized sheet steel.



■ **MLW-455** **Magnet tool holder 455 mm long**

A clear and neat way to store tools. Each tool is always ready to hand. The strip is made of aluminium with clamps of plastic. It has two holes for wall fastening or to fix it onto a perforated tool board (delivered without tools).



■ **WH-440** **Tool Holder 440 mm**  
**capable to hold up to 19 tools**

A clear and neat way to store tools. Each tool is always ready to hand. The strip is made of aluminium with clamps of plastic. It has two holes for wall fastening or to fix it onto a perforated tool board (delivered without tools).



■ **IND-601703**  
Holder, 45 mm long



■ **IND-601704**  
Holder, 23 mm long  
■ **IND-607703**  
Holder, 45 mm long



■ **IND-601727**  
Holder, 12 mm wide



■ **IND-601720**  
Holder, 20 mm deep  
■ **IND-601721**  
Holder, 32 mm deep

■ **IND-601730**  
Holder, 18 mm wide



■ **IND-601734**  
Holder, for 1/2" box nut



■ **IND-601756**  
Holder, Ø 21 mm,  
height: 50 mm  
one side closed



■ **IND-601723**  
Holder, 20 mm round



■ **IND-611071**  
Tool Holder, 13-15 mm

■ **IND-601725**  
Holder, 58 mm round

■ **IND-611074**  
Tool Holder, 25-27 mm



- **IND-603070** **Holder round Ø70 mm**  
Perfect for storing cordless guns.



- **IND-603080** **Holder round Ø80 mm**  
Perfect for storing cordless guns.



- **SLK-S-17080** **Storage Box Set 5 pcs.**  
**Size: 170 x 100 x 80 mm Total length 520 mm**

- **SLK-17080** **Storage Box**  
**Size: 170 x 100 x 80 mm**

- Variabel mountable
- Robust style
- Clear arrangement
- Stackable



- **SLK-S-9050** **Storage Box Set 5 pcs.**  
**Size: 90 x 100 x 50 mm Total length 520 mm**

- **SLK-235130** **Storage Box**  
**Size: 235 x 160 x 130 mm**

- Variabel mountable
- Robust style
- Clear arrangement
- Stackable

■ **CMU-099**

**Allround Clips Storage Container with 99 compartments**

Very spacious clips and small parts storage container with up to 99 compartments. Thanks to the variable dividers this container offers multiple fields of application. Made of shockproof plastic, with robust locks.

Delivery without content.

Dimensions: 420 x 300 x 410 mm



■ **CKM-021**

**Clips and small parts storage box with 21 compartments**

Small parts storage box made of milky-transparent, shockproof plastic, with robust locks. Thanks to the variable arrangement of the dividers you can create bigger or smaller compartments as needed.

Delivery without content.

Dimensions: 364 x 248 x 50 mm





■ **CMM-018**

**Clip storage cabinet  
with 18 compartments**

Small parts storage case for mobile use. Perfect to organize clips, rubber spacers, sensor adhesive pads and other small parts. The 18 boxes can be taken out separately if needed.

Dimensions: 300 x 300 x 150 mm



■ **QT-5050**

**Divider for clip storage cabinet CMM-018**

The divider separates each box of the clip storage cabinet in two compartments.



■ **CKM-007**

**Small parts storage box with 7 compartments**

165 x 112 x 31 mm

delivered empty, without content



■ **RW-201**

**Rolling Workshop STANLEY II**

The rolling workshop Stanley II is the well-priced alternative made of plastic to the model „Professional“ (item no. RW-205).

The tool trolley can be demounted with snap closures in two parts for transportation.

**Features:**

- Removable tool tray in the top. Thereunder is a big compartment that offers enough room for a pair of suction cups.
- Drawer for tools or small parts.
- Higher drawer for tool storage.
- Big bottom compartment for power tools or other big tools.
- Extractable handgrip for convenient and easy transportation.

Delivery without Tools.

Dimensions: 448 x 348 x 778 mm





## ■ RW-205

### Rolling Workshop STANLEY “Professional”

The rolling workshop offers enough space for all tools and supplies that the auto glass professional needs. Thanks to the compact dimensions this tool trolley is an excellent companion for the mobile service. With a single movement the tool trolley can be demounted in two parts for transportation.

#### Features:

- removable tool tray in the top
- thereunder is a big compartment that offers enough room for a pair of suction cups
- drawer for tools
- big bottom compartment for power tools or other big tools
- extractable handgrip for convenient and easy transportation
- retainer for extension cords or air hoses

Delivery without Tools.

Dimensions: 568 x 389 x 730 mm





■ **RW-217**

**Rolling Workshop STANLEY FatMax**

**Features:**

- Rolling workshop made of metal and plastic with two drawers, a large storage bin and a detachable, 30 cm high toll box
- 20" Detachable metal plastic tool box with removable tray
- Large metal rust proof latches with padlock eye
- Two deep 4" drawer with ball bearing slides
- One drawer with removable boxes for small parts
- Large metal storage bin that provides extra large capacity of portable tool storage
- Heavy duty 7" wheel

Delivery without Tools.

Dimensions: 568 x 389 x 893 mm





■ RW-239

### Rolling Workshop STANLEY FatMax

#### Features:

- Rolling workshop made of plastic for the transport of large amounts of equipment and materials - saves time and effort on repeated trips to the van!
- Robust telescopic handle
- Opens up easily into a 4 level workstation
- Giant lower bin ideal for bulky equipment and tools
- Tool box with lift-out tray for smaller tools, which fits neatly into the fold-out lid

Delivery without Tools.

Dimensions: 549 x 413 x 733 mm



■ **WZK-7749-R Tool Box on wheels dimensions: 610 x 375 x 415 mm**

Robust and very spacious plastic box on wheels with an extendable handle. With two movable shelves and two further boxes for small items this case is the perfect companion in the mobile service.

The case can be used as a seat or pedestal. Maximum load is 100 kg.



■ **WZT-5836 Tool bag 580 x 360 mm**

The tool bag from a very strong Nylon was specially concept for workplace with missing storage place for small tools. (Such as windscreen trestle, workbench and open tool carts). Also for mobile job.

Delivered empty, without content.





■ **WZK-6732S** **Tool Box with compartments in the lid**



Large, spacious tool box 670 x 323 x 251 mm. Sturdy plastic body with removable organiser extension for small parts.



■ **WZK-5829S** **Tool Box with shelf**



Large, spacious tool box with shelf 584 x 293 x 295 mm. Very sturdy metal body can be loaded up to 100 kg, possibility to lock with pad-lock, large metal latches.









■ **EWS-620**

**ProGlass Windscreen Trestle Economy**

- well-priced and nevertheless sturdy windscreen trestle
- made of shock-resistant lacquered steel tube Ø 22 mm
- soft coating is made of non-skid material and particularly resistant
- width multi adjustable to carry almost all sizes of glasses
- delivered completely mounted
- load capacity: 80 kg

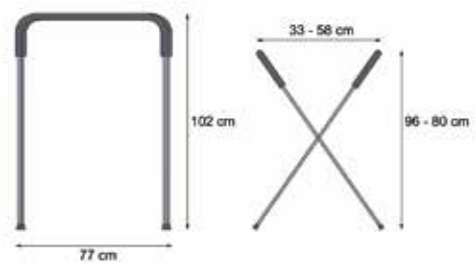

■ **HWS-760**

■ **HWS-680**

**ProGlass Windscreen Trestle Heavy Duty**

**ProGlass Windscreen Trestle Heavy Duty**

- very sturdy version - load capacity up to 100 kg
- made of shock-resistant lacquered steel tube Ø 30 mm
- soft coating is made of non-skid material and particularly resistant
- width multi adjustable to carry almost all sizes of glasses
- delivered demounted, with illustrated manual (assembly in about 10 minutes)



HWS-760



HWS-680



■ SWS-580

**Windscreen Trestle Standard**

■ SWS-580-01

**Rubber Plates for SWS-580, single**



SWS-580-01

- classical design, made of lacquered steel tube Ø 25 mm
- four big rubber plates to hold the glasses firmly
- width multi adjustable to carry almost all sizes of glasses
- delivered partly mounted
- load capacity: 60 kg

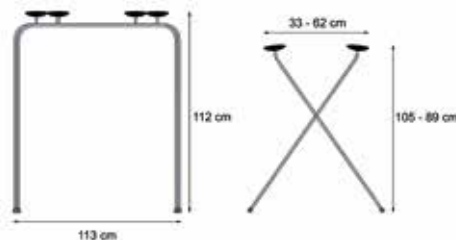

■ NWS-1080

**ProGlass Windscreen Trestle Heavy Duty for commercial vehicles and trucks**



- very sturdy version - load capacity up to 100 kg
- made of shock-resistant lacquered steel tube Ø 30 mm
- soft coating is made of non-skid material and particularly resistant
- width multi adjustable to carry different sizes of glasses
- extra large frame length for tall and heavy glasses
- delivered demounted, with illustrated manual (assembly in about 10 minutes)

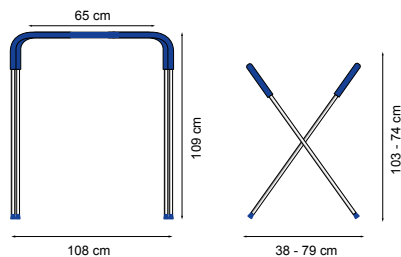

■ **SRW-006**



**Glass Rack, wall-mounted, with 6 compartments**

Rack completely made of high-grade painted steel. Non-skid rubber caps and foam upholstery hold all sizes of glasses firmly and give a full bearing. Rack delivered with diverse fixing material.

- Dimensions: 710 x 585 x 120 mm
- Pipe Diameter: 34 mm
- Pipe Length: 665 mm
- Pipe Distance: 40 mm
- Load capacity 120 Kg
- Weight: 9400 g



■ **SGS-05**

■ **SGS-09**

**Glass Rack with 5 compartments, non collapsible**

**Glass Rack with 9 compartments, non collapsible**

- rack completely made of high-grade painted steel
- non-skid rubber cams and supports hold all sizes of glasses firmly
- tubes are all padded with resistant material
- rack delivered completely mounted, ready to bolt to the vehicle's bottom (fixing material included)

**Data SGS-05:**

- length: 54 cm
- width: 81 cm
- height: 60 cm
- net weight: 11,5 kg



**Data SGS-09:**

- length: 83,5 cm
- width: 81 cm
- height: 60 cm
- net weight: 16,4 kg





■ **SGM-05**

**ProGlass Glass Rack with 5 compartments, collapsible**

■ **SGM-09**

**ProGlass Glass Rack with 9 compartments, collapsible**

- rack completely made of high-grade aluminium - this means no peeling off paint, no rust
- non-skid rubber cams and supports hold all sizes of glasses firmly
- tubes are all padded with resistant material
- rack delivered completely mounted, ready to bolt to the vehicle's bottom (fixing material included)
- in case of disuse, collapsible in a few seconds by pulling out the locking pins

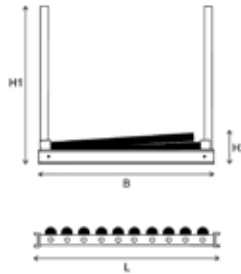

**Data SGM-05**

L = 52 cm  
 B = 77 cm  
 H1 = 55 cm  
 H2 = 12 cm  
 Weight: 8.5 Kg

**Data SGM-09**

L = 83 cm  
 B = 77 cm  
 H1 = 55 cm  
 H2 = 12 cm  
 Weight: 13.7 Kg



■ **SWW-880**

**ProGlass Windscreen cart with three floors**

High-quality processed windscreen trolley made of plastic and aluminum. The trolley consists of three levels including four rubber plates for placing and preparing windshields. Delivery without content.

Dimension: 670 x 440 x 890 mm  
 Working height: 890 mm  
 Floor height: 320 / 220 mm  
 Loading capacity: 100 Kg



■ **SHP-150**

**ProGlass Vacuum Lifter Kit**

■ **SHP-150-1**

**ProGlass Vacuum Lifter, single**

Easier and safer to attach than common suction lifters with clamp lever technology - the bell-shaped rubber pads already adhere onto the glass surface by slightly pressing them down!

- concave rubber pad (Ø 150 mm) for optimal hold, also on strongly curved glass surfaces
- fixed with the integrated vacuum pump
- safety ring at the pump plunger for optical monitoring of the vacuum
- load capacity for each single lifter is 60 kg

**SHP-150 Kit contains:**

- 2 single vacuum lifters SHP-150-1
- 1 elbow pad
- 1 plastic case 365 x 200 x 180 mm



**■ SHP-200-1**
**Vacuum Lifter with curved suction cup for heavy glasses single, in plastic case**

- concave rubber pad (Ø 200 mm) with multiple-seal lip for optimum hold, also on strongly curved glass surfaces
- fixed with the integrated vacuum pump
- red safety ring at the pump plunger enables optical monitoring of the vacuum
- load capacity for each lifter is 80 kg

**■ SHP-230-1**
**Vacuum Lifter for heavy glasses single, in plastic case**

- large rubber pad (Ø 230 mm) with multiple-seal lip for optimum hold, also on slightly curved glass surfaces
- fixed with the integrated vacuum pump
- red safety ring at the pump plunger enables optical monitoring of the vacuum
- load capacity for each lifter is 120 kg



■ **JP-135**

■ **JP-140**

**Vacuum Lifter JetPack with AirForce Technology**

**Vacuum Lifter Kit JetPacks with AirForce Technology**

Simple and safe installation, thanks to the curved pad the suction cup sticks already if you press it down. The suction is done fully automatically by an electronically controlled vacuum technology. If there is a loss of pressure, the system adjusts itself automatically, so that the suction cup cannot be detached. (Only when electronics are switched on)

- Curved suction pad (Ø 180 mm) for optimal adhesion, also on strongly curved glasses
- Load capacity for each lifter is 70 kg



■ **SHV-125-1**

**2-Cup Suction Lifter, single with 1-hand-operation**

- Particularly flexible concave rubber pads fit onto all glasses
- fast 1-hand-operation for serial assembling or transportation
- diameter of rubber pad is 125 mm
- load capacity for suction lifter is 40 kg



1 place it on the glass



2 press it down



3 done!



4 pull lever to release

■ **SHE-070**

**Hand-held Suction Lifter Ø 70 mm, load capacity 8 kg**

The vacuum lifter with pistol grip and one-hand locking handle is especially suitable for exchanging mirror glasses as well as for setting small quarter glasses. To release the vacuum push the grey-coloured release button.



■ **EMS-055**

**Mini Single Suction Lifter Ø 55 mm**

The vacuum lifter with clamping lever is especially suitable for exchanging mirror glasses as well as for setting small quarter glasses.

Load Capacity: 8 Kg  
Suction Pad: Ø 55 mm  
Total Height: 70 mm





■ **PSL-150-1**

**ProGlass 2-Cup Suction Lifter „Pro Deluxe“**

Easier and safer to attach than common suction lifters with clamp lever technology - the bell-shaped rubber pads already adhere onto the glass surface with slight pressing - even before pressing down the lever!

- 2 concave suction cups with large seal avoid slipping or coming off
- pin-jointed heads for an optimum hold on all curved glasses
- slotted handle to pass a belt through
- load capacity for each lifter is 60 kg
- frame made of light-weight and shock-resistant plastic
- diameter of suction cup 150 mm



■ **PSH-120-1**

**ProGlass 2-Cup Suction Lifter „Pro“**

- pin-jointed heads for optimum hold on curved glasses
- slotted handle to pass a belt through
- load capacity for each lifter is 60 kg
- frame made of light-weight and shock-resistant plastic
- diameter of suction cup 115 mm





■ PHX-150-1

**ProGlass Single Suction Lifter „Pro Deluxe“**

- single-cup suction lifter for one-hand operation with concave suction cup 150 mm
- for easier and safer handling
- frame made of light-weight and shock-resistant plastic
- load capacity 30 kg



■ PHL-115-1

**ProGlass Single Suction Lifter „Pro“**

- handy single-cup suction lifter for one-hand operation
- diameter of suction cup 115 mm
- frame made of light-weight and shock-resistant plastic
- load capacity 30 kg



■ HRS-100

**ProGlass Adhesive Agent For Suction Cups can at 100 ml**



It highly degreases the rubber and improves the adhesion between rubber and glass (the glass must be clean as well). Other cleaning agents with a similar efficient formula will destroy the rubber surface within short time.

■ **DSA-125-1**

**3-Cup Suction Lifter „Pro“**



- Extremely secure because of three stand-alone suction pads
- Very robust aluminium body
- Diameter suction pad 123 mm
- load capacity 100 kg

■ **SHG-200**

**Single Suction Cup with spherical rubber pad**



- spherical rubber pad also fits extremely curved glasses
- fast application without lever or pump
- suction cup diameter: 165 mm
- material: rubber
- load capacity per piece: 20 kg

■ **GT-3516**

**Plastic Window Carrier, load capacity 80 Kg**



The window carrier allows you to easily carry large windows without the use of suction lifters and with only one person. Made of fiber-reinforced plastic.



■ **WSR-800**

**Automated Windscreen Repair System  
WSR-800 GECKO**

■ **WSR-800K**

**Automated Windscreen Repair System  
WSR-800 GECKO with case**



*quicklink to the  
product video*



The **WSR-800 GECKO** system is the highly-automated and user-friendly solution for perfect windscreen repairs.

In the latest Generation 4 of the computer-controlled repair system, the electronics and software have been revised and improved once again. All work steps are integrated into an automatic programme. The new 5.0 inch colour display guides the operator and keeps him informed about the repair progress. The process reliability realised in this way enables every employee to carry out a repair effortlessly and without errors - and always with optimal results.

- new 5.0 inch colour display
- improved electronic control
- optimised software

The repair fixture works with a two-chamber pressure/vacuum system. The outer chamber holds the fixture safely attached to the glass surface with a permanent vacuum. Through the inner chamber the glass damage is vacuumized, the resin injected and the chamber pressurized and vacuumized in several cycles. The UV lamp with high-power LEDs cures the repair completely in only 50 seconds.

# GECKO

✓ patented repair system

✓ simple operation

✓ minimal time required

✓ effective damage repair





■ **WSR-800W** **Automated Windscreen Repair System  
WSR-800 GECKO with tool cart**

By combining the WSR-800 GECKO repair system with the WSW-800 workshop trolley, you always have a workstation ready for stone chip repair. The GECKO stands on the upper shelf at a comfortable working height, the consumables and the components find their place in the lockable drawers. The two platforms underneath offer generous storage space for cleaning paper, window cleaners, vehicle protectors, etc.



■ **WSW-800** **Tool Cart with three floors & two drawers**

High-quality workshop trolley made of plastic, aluminum and painted drawers made of sheet steel. The trolley consists of three floors including two drawers with a height of approx. 107 mm and 155 mm. Both drawers have a full extension and can be locked to protect against unauthorized access.

- Dimension: 750 x 460 x 1103 mm
- Loading capacity: 100 Kg
- Working height: 968 mm
- Drawer Dimension: 504 x 383 x 54/110
- Weight: 24.4 kg
- Material: Plastic / Metal
- Color: Grey



■ **WSR-800-SH** **Cover for WSR-800/K/W GECKO**



Protective cover for all WSR-800 GECKO from the second generation onwards. Attention! Does not fit the first generation WSR-800, please pay attention to the dimensions.

- Total length: 370 mm
- Total width : 270 mm
- Height: 130 mm

■ **WSR-800K-BO** **Booster for WSR-800/K**



The NOMAD POWER PRO 700 is a lithium-based power pack. **With special adapter cable for mobile use of the WSR-800/K (up to 10 x repairs possible per battery charge).**

It combines 4 functions:

- Battery-Supplied jump start (Booster) for 12V vehicle (motorcycle, quad, car ect.)
- independent supply for all current electrical equipment (smartphone, tablet, computer, ect.)
- Emergency lamp
- 2 x USB-Ports 5V, for charging smartphone, tablet, GPS, ect.
- 1 x 15V (10A), ideal for camping, to supply a 12V electrical appliance (cool box, fan, ect.)

■ **WSR-800-7** **Power cable 12 V, length 7.5 m, for ProGlass WSR-800 GECKO**



With the 12 V connection cable, the GECKO becomes mobile!

Simply connect this power cable to the GECKO instead of the AC power supply and connect the battery terminals to the 12 V vehicle battery of your own vehicle or to a portable booster and you can use your GECKO for mobile repairs on site.

**ATTENTION:**

Not suitable for 1st generation WSR-800 devices (serial number starting with 1.00xxx).

**The cable is only suitable for the WSR-800 GECKO!**

■ **WSR-800-PH** **Positioning aid for WSR-800 GECKO, consisting of 2 templates**

■ **WSR-800-PHS** **Positioning set for WSR-800 GECKO, contains 2 templates and 1 chalk marker**



The positioning aid makes it easier to fit the GECKO repair unit precisely when an inspection mirror cannot be used. For example, for repairs on locked vehicles or if it is not possible to attach the mirror from the inside, or for repairs in the black area of a windscreen.

1. Remove the protective film and place the template made of static adhesive film exactly over the point of impact.
2. Run around the template with the chalk marker.
3. Lift off the template again and position the repair unit according to the chalk contour.

■ **DRV-500**

**Repair Fixture Seal for WSR-800, 1 piece**



The V-seal is responsible for the secure hold of the repair base on the window. The material (NBR) has medium resistance to the chemicals used. Frequent contact with resin, however, can cause swelling. In this case, and in the event of any mechanical damage, the seal must be replaced.

■ **DRO-116**

**Injector/Resin Tank Sealing Kit, in 6 parts for WSR-800**



The set contains 2 seals for the resin tank (Ø 11.6 mm), the resin chamber (Ø 7.5 mm) and the injector (Ø 11.6 mm). The material (MVQ - silicone rubber) has good chemical resistance. This means that the seals keep their shape despite regular, direct contact with the repair resin. However, we recommend replacing all three seals after 6 months, as there is a certain amount of wear / abrasion during use.

Set consisting of:

- 4 MVQ O-rings, red, Ø 11.6 mm
- 2 MVQ O-rings, red, Ø 7.5 mm

■ **MSF-010**

**Multi Silicone Grease, tube at 10 ml**



Highly adhesive, transparent silicone grease for the care of the O-rings on the plug connections of the WSR-800 GECKO. Regular use of silicone grease will significantly increase the life of the seals.

**Attention:** Do not use for seals made of MVQ (silicone rubber). These could be resolved.

■ **WSR-800-1**

**Repair Fixture for ProGlass WSR-800 GECKO**



Complete repair fixture with resin chamber and connections. Can only be used in connection with the repair system WSR-800 GECKO (as well as the WSR-800 of the 1st generation). The repair fixture is sucked to the window via the black connection using negative pressure. The blue connection acts on the resin chamber with negative and positive pressure. If you suspect a defect in your fixture or only need individual parts, please contact our sales department.

■ **WSR-800-3**

**Tray for Repair Fixture for ProGlass WSR-800 GECKO**



The tray is attached to the windscreen near the damaged area. So it guarantees a safe and comfortable workflow.

Before the repair:

- Hang the couplings of the connecting hose in the two recesses at the bottom.
- Hang the repair fixture in both arms, fill the resin tank, connect the hose couplings.

After the repair:

- Disconnect the hose and hang it into the two recesses.
- Remove the repair fixture and hang it in both arms again.

■ **UVN-806**

**UV lamp for WSR-800 GECKO**



UV lamp with 6 high-performance LEDs. Can only be used in conjunction with the WSR-800 GECKO repair system.

**ATTENTION:**

Not suitable for WSR-800 devices of the 1st generation (serial no. starting with 1.00xxx). Please always state the serial number of your device in the event of damage or when ordering spare parts.

■ **WSR-800-4** **Connection Hose for ProGlass WSR-800 GECKO**



The hose has a length of approx. 3.0 m and connects the WSR-800 GECKO to the repair base.

**ATTENTION:**

Not suitable for WSR-800 devices of the 1st generation (serial no. starting with 1.00xxx). Please always state the serial number of your device in the event of damage or when ordering spare parts.

■ **WSR-800-5** **Y-Connection Hose for ProGlass WSR-800 GECKO**



The Y-hose enables the simultaneous, parallel repair of two stone chips with the repair system WSR-800 GECKO (or the WSR-800 of the 1st generation).

In addition to the Y-hose, at least one additional repair base WSR-800-1 and an extension WSR-800-6 are required.

■ **WSR-800-6** **Extension Hose for ProGlass WSR-800 GECKO**



The hose has a length of approx. 3.0 m and can be used to increase the range of the original connection hose of the WSR-800 GECKO (or WSR-800 1st generation).

Alternatively, the extension can also be used with the Y-connection hose WSR-800-5. One or two extensions (in parallel on the output side) can be used here.

In any case, the maximum hose length of approx. 6.0 m must be observed.

■ **WSR-150-N****ProGlass Professional Windscreen Repair Kit  
for stationery use**■ **WSR-150-A****ProGlass Professional Windscreen Repair Kit  
for mobile use**

*quicklink to the  
product video*



This professional windscreen repair kit is a result of our longtime experience in windscreen repair. It contains all components necessary for professional work and for optimum results. Almost no other system is equipped so completely as this kit. By that the price is remarkably favorable - do not hesitate to compare the contents list to systems from other suppliers.

The stationary kit includes a 230 V mains operated UV lamp. The mobile kit includes a 12 V operated UV lamp that connects with a cigarette lighter or vehicle power outlet.

Besides the large range of tool components, the kit also includes all consumables for at least 20 repairs. Each of these consumables can be bought later separately and at fair prices.

**Features:**

- high-quality and long-life components
- very complete professional case for all kinds of stonechips
- all components and consumables also available separately
- detailed instruction manual included



**Steinschlagschaden?**  
**Kostenlose\* Reparatur HIER!!!**

\* die Teilhaskoversicherung übernimmt die Kosten der Reparatur in der Regel in voller Höhe - trotz vereinbartem Selbstbehalt

Die meisten Steinschlagschäden an Windschutzscheiben sind reparabel. Sprechen Sie mit uns darüber!

Wir informieren Sie gerne zu den technischen Möglichkeiten und den Vorgaben und Einschränkungen des Gesetzgebers.

© 2013 Elias

**WSR-150-P**

**Kit contains:**

- ProGlass repair fixture (WSR-150-1N)
- resin chamber small, 3/16" (WSR-150-2N)
- connection hose (WSR-150-3)
- pressure/vacuum pump (WSR-150-5)
- inspection mirror with suction cup (MC-500)
- LED UV Lamp 2 W (230V / 50 Hz) (UVN-200-LED)  
 or LED UV Lamp 2 W (12V) (UVA-200-LED)
- cordless mini drill 3.6V (AM-361)
- carbide probe (CP-5040)
- cracker (CRK-109)
- LED Penlight (PLE-160) incl. batteries
- 1 repair resin, 15 ml (VR-515)
- 1 pit filler resin, 15 ml (VR-415)
- 1 glass repair polish, 25 ml (SP-025)
- 1 dome magnifier 15x (SL-015)
- accessory box with following contents:
  - 3 syringes (1942)
  - 3 cannulas (2496)
  - 20 protective sheet (MR-300)
  - 10 scraper blades (RK-10)
  - 5 injector seals 3/16" (DR-475)
  - 1 carbide drill bit, tapered 0.8 mm (KMB-085-1)
  - 1 carbide drill bit, tapered 1.0 mm (KMB-105-1)
  - 1 carbide drill bit, round 0.8 mm (KMK-110-1)
  - 1 carbide drill bit, round 1.0 mm (KMK-120-1)
  - 1 grinding and polishing kit, in 6 parts (AM-360-FPS)
  - 1 bull's eye maker (SSK-790)
- detailed instruction manual
- advertising poster (actually only for A, CH, D)
- rugged, foam lined plastic case  
 500 x 420 x 125 mm



■ **WSR-150-1N ProGlass Repair Fixture (without resin chamber!)**

The 125 mm big sucker of the fixture is mounted to the glass securely by pushing the pump plunger only a few times (optical control through red safety ring on the pump). The solid light alloy arm is movable and swivelling so that the resin chamber can be adjusted over the impact point easily and very precisely.

By turning the screw downward the resin chamber will become vacuum-sealed to the glass. Thanks to the spherical seat the resin chamber will align itself at right angle over the impact point. This guarantees that the seal does not impose more pressure upon the glass than necessary.

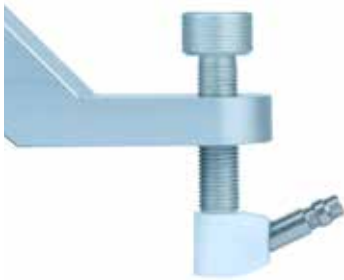

■ **WSR-150-2N ProGlass Resin Chamber, 3/16" Inch for all standard repairs**

The seal of this chamber has an inside Ø of 4.75 mm. It is dedicated to perform all standard repairs with an impact no bigger than 5 mm. The chamber can be used for repairs on all flat and vertical glasses.

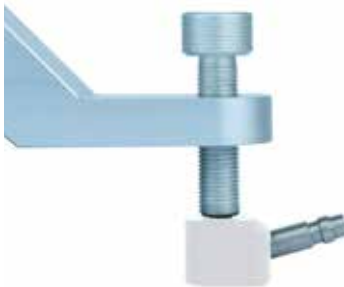

■ **WSR-150-6N ProGlass Resin Chamber, 3/8" Inch for the repair of large damages**

The seal of this chamber has an inside Ø of 9.5 mm. It is suitable for large stone chips as could be found at commercial vehicles or busses. Due to its extra large size, it is also applicable for two impact points close to each other. The chamber can be used for repairs on all flat and vertical glasses.



■ **WSR-150-5** **Pressure/Vacuum Pump for WSR-150**



Pressure/vacuum pump for our ProGlass Professional Windscreen Repair Kit WSR-150. Also compatible to other repair systems on the market, e. g. AEGIS or Würth.

■ **WSR-150-3** **Connection Hose for WSR-150 / Total length: 96 cm**

■ **WSR-300-3** **Connection Hose for WSR-300 / Total length: 166 cm**



The hose connects the pressure/vacuum pump with our resin chambers. It is also compatible to other repair systems on the market, e. g. AEGIS or Würth.

■ **SHU-3237** **Suction Holder, universal, Ø 32-37 mm**



Use the suction holder to fix the pressure/vacuum pump WSR-150-5 to a windscreen or to other smooth surfaces. This is for example very helpful when repairing windscreens on commercial vehicles.

■ **RF-050** **Refill Kit for WSR-150 sufficient for at least 50 repairs**



Kit contains:

- 2 repair resins (item no. VR-515)
- 1 pit filler resin (item no. VR-415)
- 2 injector seals (like item no. DR-475)
- 10 scraper blades (item no. RK-10)
- 50 protective sheet (like item no. MR-300)
- 4 syringes (item no. 1942)
- 2 cannulas (item no. 2496)

**■ RS-2030****Resin Dispensing Kit**

Kit contains 6 syringes item 1942 and 3 cannulas item 2496 for the laminated glass repair.

**■ 1942****Syringe (polypropylene), 1 ml**

Reusable syringe made of polypropylene for exact dosage of resin.

**■ 2496****Cannula 2.0 x 70 mm**

Reusable cannula made of stainless steel for exact dosage of resin in connection with the syringe 1942.



■ **VR-515**

**Repair Resin ExtraPlus, extra thin,  
dropper bottle at 15 ml**

Extra thin repair resin, excellent crack filler.

viscosity at 25°C: 10-20 mPa\*s  
shore hardness: D75



■ **VR-415**

**Pit Filler Resin Extra, thin,  
dropper bottle at 15 ml**

More fluid pit filler, for a hard and shiny finish.

viscosity at 25°C: 90-100 mPa\*s  
shore hardness: D80



■ **DR-475**

**Injector seals 3/16" Inch for repair system WSR-150 / WSR-300  
package at 5 pieces**

Injector seal (small) for the resin chamber WSR-150-2N.

inside-Ø approx. 4.75 mm, outside-Ø ca. 9.75 mm



■ **DR-950**

**Injector seals 3/8" Inch for repair system WSR-150 / WSR-300  
package at 5 pieces**

Injector seal (large) for the resin chamber WSR-150-6N.

inside-Ø ca. 9.5 mm, outside-Ø ca. 16.0 mm



■ **WSR-100**

**ProGlass Windscreen Repair Kit for stationary use**

■ **WSR-100-A**

**ProGlass Windscreen Repair Kit for mobile use**

Simple and economic repair system for the professional windscreen repair. The system WSR-100 is distinguished for businesses with a lower repair volume or as a second system.

In this system the pressure and vacuum needed to perform a repair is produced by screwing the plastic injector's piston in and out. The simple construction of the whole system ensures a safe and easy operation. Thanks to the high-quality and extremely thin ProGlass repair resin even finest cracks can be repaired. The system can also be used to repair damages with a finely smashed or very dirty point of impact because an electric mini drill is also included.

Kit contains:

- ProGlass repair fixture (WSR-100-1)
- inspection mirror with sucker (MC-500)
- LED UV Lamp 2 W (230V / 50 Hz) (UVN-200-LED) or LED UV Lamp 2 W (12V) (UVA-200-LED)
- Cordless Mini Drill 3,6 V with charging unit, collet set and polishing set (AM-361)
- carbide probe (CP-5040)
- cracker (CRK-109)
- Penlight (PL-140), batteries included
- suction cup lubricant, 60 ml (VS-060)
- glass repair polish, 25 ml (SP-025)
- polishing kit in 6 parts (AM-360-FPS)
- accessory box with following contents:
  - 2 plastic injectors (INJ-M14-F)
  - 1 repair resin, 5 ml (VR-505)
  - 1 pit filler resin, 5 ml (VR-405)
  - 20 protective sheet (MR-300)
  - 10 scraper blades (RK-10)
  - 1 carbide drill bit, tapered 1.0 mm (KMB-105-1)
  - 1 carbide drill bit, round 1.0 mm (KMK-120-1)
- detailed instruction manual
- rugged plastic case 450 x 360 x 106 mm with rigid foam lining



■ **WSR-100-1** **Repair Fixture for WSR-100**



Injector holder made of aluminium with two PVC suction cups (Ø 37 mm). For the simple and safe positioning of the injector over the point of impact. Comes with one injector INJ-M14-F.



■ **INJ-M14-KIT** **Repair Resin with Injector**

Kit consisting of one bottle with 5 ml repair resin ExtraPlus and one plastic injector.



■ **INJ-M14-F** **Universal Injector for Windscreen Repair**

Well-priced injector for the ProGlass WSR-100 windscreen repair kit. Compatible with many repair systems on the market like for example Duobond, PMA or Talon (metric fine thread: M12x1,25).



■ **INJ-007-DI** **Seal for INJ-M14-F Injector Ø 7.0 mm, package at 5 pieces**

Suitable for all injector with attached inside dimension:

- Length: 17,0 mm
- Diameter: 7,0 mm
- Plunger Diameter: 4,5 mm

## Windscreen Repair Resins

Our resins for laminated glass repair can be used with all repair systems on the market. They cure by radiation with UV light with a wave length of 360 - 380 nm. The herein mentioned data for viscosity and shore hardness shall help you to choose the right product for your application (by the way, at 25°C water has a viscosity of approx. 1.0 mPa\*s, motor oil at 25°C of approx. 100 mPa\*s and honey - depending on the type - of approx. 4,000 - 10,000 mPa\*s). As the resins have a limited shelf life they should be bought in quantities as needed and

always be stored in a dark and cool place. If stored properly our resins have a shelf life of at least 12 months from the production date, from the delivery from our stock of at least 9 months. To ease control you will find the best before date printed on each bottle. This ensures the use of only fresh products and gives you more application safety. For further information please also refer to the technical data sheet.



■ **VR-505AF**

**Repair Resin ExtraPlus AF, extra thin, acid-free formulation, dropper bottle at 5 ml**

■ **VR-515AF**

**Repair Resin ExtraPlus AF, extra thin, acid-free formulation, dropper bottle at 15 ml**

This repair resin is absolutely acid-free. Thereby it can also be used by persons who are sensitive to the acrylic acid contained in conventional resins. Commonly occurred discomfort like irritation of skin, eyes or the respiratory system, headache or even light sickness do no longer occur when using this acid-free resin.

Extra thin repair resin, excellent crack filler.

viscosity at 25°C: 10-20 mPa\*s  
shore hardness: D75



■ **VR-405AF**

**Pit Filler Resin Extra AF, thin, acid-free formulation, dropper bottle at 5 ml**

■ **VR-415AF**

**Pit Filler Resin Extra AF, thin, acid-free formulation, dropper bottle at 15 ml**

This pit filler resin is absolutely acid-free. Thereby it can also be used by persons who are sensitive to the acrylic acid contained in conventional resins. Commonly occurred discomfort like irritation of skin, eyes or the respiratory system, headache or even light sickness do no longer occur when using this acid-free resin.

More fluid pit filler, for a hard and shiny finish.

viscosity at 25°C: 90-100 mPa\*s  
shore hardness: D80



■ **VR-505**

**Repair Resin ExtraPlus, extra thin, dropper bottle at 5 ml**

■ **VR-515**

**Repair Resin ExtraPlus, extra thin, dropper bottle at 15 ml**

Extra thin repair resin, excellent crack filler.

viscosity at 25°C: 10-20 mPa\*s  
shore hardness: D75

■ **VR-305**

**Repair Resin Extra, thin, dropper bottle at 5 ml**

■ **VR-315**

**Repair Resin Extra, thin, dropper bottle at 15 ml**

Thin repair resin for all type of stone chips.

viscosity at 25°C: 20-30 mPa\*s  
shore hardness: D76



■ **VR-405**

**Pit Filler Resin Extra, thin, dropper bottle at 5 ml**

■ **VR-415**

**Pit Filler Resin Extra, thin, dropper bottle at 15 ml**

More fluid pit filler, for a hard and shiny finish.

viscosity at 25°C: 90-100 mPa\*s  
shore hardness: D80

■ **VR-205**

**Pit Filler Resin Standard, dropper bottle at 5 ml**

■ **VR-215**

**Pit Filler Resin Standard, dropper bottle at 15 ml**

Highly viscous pit filler for a hard finish.

viscosity at 25°C: 300 mPa\*s  
shore hardness: D78

■ **UV-528**

**Equalizer Rock Star Roadie Windscreen Repair Kit**

This system does not need a repair fixture. Instead it uses a pedestal that is bonded directly over the point of impact and that works as the resin chamber. Simple repair system for occasionally use (e. g. for dealers of used cars).



Kit contains:

- 1 injectors (INJ-581)
- 1 connection hoses (H-538)
- 1 UV battery lamp (batteries included)
- 1 flow regulators
- 1 cure guard
- 1 carbide probe
- 20 pedestals (like P-536)
- 20 adhesive pads (like AS-537)
- 1 repair resin, ExtraPlus (VR-505)
- 1 pit filler resin, thin (VR-405)
- 1 scraper with blade
- 20 protective sheet
- 1 Glass Repair Polish (SP-025)
- 1 instruction manual



■ **P-536**

**Pedestal for UV-528 package at 25 pieces**

The pedestals are self-adhesive and can be used several times.

Only the adhesive pad has to be exchanged after each use.



■ **AS-537**

**Adhesive Pads for UV-528 package at 25 pieces**

Use these adhesive pads to renew the pedestals P-536 and as an additional adjustment for repairs on strongly curved glasses.



■ **MR-300**

**Protective sheet, package at 20 pieces**

Squares (approx. 32 x 32 mm) of transparent special foil to cover the repair area during UV irradiation.



■ **RK-10**

**Scraper Blades 40 mm wide, package at 10 pieces**

Top quality industrial blades with a thickness of 0.009 (=0.23 mm) and a solid metal back. Each blade has a single paper wrapping in the bag to prevent you from injuries.

■ **RK-10HD**

**Heavy Duty Scraper Blades 40 mm wide, package at 10 pieces**

Heavy Duty industrial blades with a thickness of 0.012 (=0.30 mm) and a solid metal back. Each blade has a single paper wrapping in the bag to prevent you from injuries.



■ **SP-025**

**Glass Repair Polish, bottle at 25 ml**

For polishing the point of impact after a repair. Apply polish on repaired area and polish by hand with a wipe or with a felt polishing wheel on the mini drill until the surface is smooth and shiny.



■ **FPS-005-N**

**Polishing Kit in 5 parts  
for mini drills**

The small felt polishing heads are ideal for polishing the pit filler surface after a laminated glass repair. Also you are able to remove punctiform scratches, marks and staining from any glass surface.

Kit contains:

- 5 felt polishing wheels Ø 25 x 5 mm



■ **MC-500**

**Inspection Mirror with suction cup**

The mirror has a diameter of 50 mm. With the small PVC suction cup it can be fixed on any plain surface. Suction cup and mirror are connected with a ball joint. Sticked to the windscreen from inside it is the perfect helper for windscreen repairs.



■ **MCM-500**

**Inspection Mirror with 3 time magnify & Suction cup**

The **3 x magnifying** mirror has a diameter of 50 mm. With the small PVC suction cup it can be fixed on any plain surface. Suction cup and mirror are connected with a ball joint. Sticked to the windscreen from inside it is the perfect helper for windscreen repairs. Through the magnify optics the failure mode become detailed visible.



■ **MCM-800**

**Inspection Mirror Ø 80 mm with 3 time magnify & Suction cup**

The **3 x magnifying** mirror has a diameter of 80 mm. With the small PVC suction cup it can be fixed on any plain surface. Suction cup and mirror are connected with a ball joint. Sticked to the windscreen from inside it is the perfect helper for windscreen repairs. Through the magnify optics the failure mode become detailed visible.



■ **MC-1000**

**Inspection Mirror with Suction cup**

The mirror has a diameter of 100 mm, with the small PVC suction cup it can be fixed on any plain surface. Suction cup and mirror are connected fixed but sideways left and right moveable. Sticked to the windscreen from inside direct over the damaged spot it is the perfect helper for windscreen repairs. Trough the large wide you catch clearly more light whereby you get a much clearer picture from the damaged spot.



■ **CP-5040**

**Carbide Probe**

Probe with carbide tip to clean the impact point and to remove loose glass particles before repairing a stone chip.

Total length: 150 mm



■ **CRK-075**

**Rescue Tool**

With this Rescue Tool you can easily escape from a vehicle in case of an emergency. The 2-in-1 tool includes a window breaker for side and rear windows (ESG), as well as a seatbelt cutter.

**Additionally this tool can be used as a cracker to simulate stone chip damages on windscreens.**



■ **CRK-109**

**Cracker**

This small cracker is appropriate to easen repairings of stone chips by widening them slightly. Therefore the resin can enter better, respectively the air can escape easier. Handling should be trained on an old windscreen first.

Total length: 110 mm



■ **CRK-150**

**Auto Center Punch**

This Center Punch is a perfect tool to simulate stone chips especial crack's and star's into the windscreen.(Demonstration/Training) Into the lowest position it is also usable to open stone chips for a better enter of the resin and escape the air. This handling should be trained on an old windscreen first.

Total length: 150 mm

■ **SSK-790**

**Bull's Eye Maker**

The bull's eye maker is used to create stone chips on an old windscreen. By that, repairing technique can be trained in a test environment instead on your clients windscreen!



■ **SSR-150**

**Stone-Chip Cleaning Brushes 150 mm Set of 2 pieces**

Stone-Chip cleaner in brush style to remove dirt and loose glass from the impact point.



■ **WSR-150-P**

**Poster „Steinschlagschaden?“  
in size DIN A1 (59.4 x 84.1 cm)**

Poster DIN A1 size that shows some typical stone chips. Placed in your sales room, it will draw your clients attention on it and makes an easy start for a sales conversation about stone chip repairing.

Sorry - actually only available in German language!





■ **SML-040**

### **Pocket Microscope 40x with LED lamp**



Pocket microscope made of plastic with LED lamp and fortyfold magnification. Auxiliary tool for the repair and examination of scratches and stone damages on windcreens. For the LED lamp two batteries size AA are needed (not included).

■ **BA-MIGNON** Alkaline Battery type Mignon AA



■ **SMK-025**

### **Pen Microscope 25x**



Pocket microscope made of aluminium and plastic with twentyfivefold magnification. Auxiliary tool for the repair and examination of scratches and stone damages on windcreens.



■ **SL-015**

### **Dome Magnifier 15x**



Simple dome magnifier made of plastic with a transparent base. Nice tool for the repair and examination of scratches and stone damages on windcreens (fifteenfold magnification).

■ **AM-361**

**Cordless Mini Drill 3,6 V with charging unit, collet set and polishing set**



- precision tool for drilling stone chips
- also suitable for grinding and polishing
- handy and powerful
- gradational adjustable from 5,000 - 18,000 r.p.m.
- 4 collets for the use of different tools
- integrated 3,6V Li-Ion battery pack
- tool weight 0.235 kg
- charging cable with interchangeable plugs (EU, GB, US, AUS)

■ **AM-360-FPS**

**Polishing Kit, in 6 parts for mini drill**



Shaft = Ø 3,1 mm

Various felt polishing heads to gloss the surface of windscreen repairs.

■ **AM-361-1**

**Collets Kit, in 3 parts (for AM-361) suitable for all mini drills with chuck of Ø 4.2 mm**



Suitable for all mini drills with a 4.2 mm chuck.

The collets suit for tools with a shaft diameter of 1.6 mm, 2.4 mm and 3.2 mm.

■ **AM-361-LG**

**Charger 3,6 V for AM-361 (Li-ion)**



technical data:

- input: 110-230V/50Hz AC
- output: 12V/500mA DC
- with interchangeable plugs (EU, GB, USA, AUS)

■ **FPS-010**

**Polishing Kit, in 10 parts for mini drill**

The small felt polishing heads are ideal for polishing the pit filler surface after a laminated glass repair. Also you are able to remove punctiform scratches, marks and staining from any glass surface.

Scope of delivery as shown.



■ **SPS-012**

**Grinding and Polishing Kit in 12 parts for mini drills**

A kit for the mini drill that complies with the requirements of car glass glaziers. Grinding adaptors to remove little corrosion spots and polishing adaptors to polish stone chip reparings.

Scope of delivery as shown.



■ **DRB-140**

**Aluminium Bridge**

With the aluminium bridge a constantly and controlled counter pressure from the inside of the windscreen can be generated. Thereby the repair result e.g. of longer cracks, can be influenced very positively. A highly expedient add-on for each windscreen repair kit. The handy bridge is also suitable for fixing freshly bonded mirror plates or sensor units.



■ **MRH-055**

**Installation/Repair Hammer**

Thanks to its two-sided head (1 x rubber cap, 1 x metal cap) this small and very handy tool can be used for various applications. Total length: approx. 175 mm / Total weight: approx. 55 g





■ **KMB-085** Carbide Drill Bits, tapered Ø 0.8 mm  
Flat tip, package at 10 pieces

■ **KMB-085-1** Carbide Drill Bits, tapered Ø 0.8 mm  
Flat tip, single

technical data:

- shaft-Ø: 1.6 mm
- length of shaft: 12.0 mm
- total length: 19.0 mm



■ **KMB-105** Carbide Drill Bits, tapered Ø 1.0 mm,  
Flat tip, package at 10 pieces

■ **KMB-105-1** Carbide Drill Bits, tapered Ø 1.0 mm,  
Flat tip, single

technical data:

- shaft-Ø: 1.6 mm
- length of shaft: 12.0 mm
- total length: 19.0 mm



■ **KMC-085** Carbide Drill Bits, tapered Ø 0.8 mm,  
rounded tip, package of 10 pieces

■ **KMC-085-1** Carbide Drill Bits, tapered Ø 0.8 mm,  
rounded tip, single

technical data:

- shaft-Ø: 1.6 mm
- length of shaft: 12.0 mm
- total length: 19.0 mm



■ **KMC-105** Carbide Drill Bits, tapered Ø 1.0 mm,  
rounded tip, package of 10 pieces

■ **KMC-105-1** Carbide Drill Bits, tapered Ø 1.0 mm,  
rounded tip, single

technical data:

- shaft-Ø: 1.6 mm
- length of shaft: 12.0 mm
- total length: 19.0 mm



■ **KMK-110** Carbide Drill Bits, round Ø 0.8 mm package at 10 pieces

■ **KMK-110-1** Carbide Drill Bits, round Ø 0.8 mm single

technical data:

- shaft-Ø: 1.6 mm
- length of shaft: 12.0 mm
- total length: 19.0 mm



■ **KMK-120** Carbide Drill Bits, round Ø 1.0 mm package at 10 pieces

■ **KMK-120-1** Carbide Drill Bits, round Ø 1.0 mm single

technical data:

- shaft-Ø: 1.6 mm
- length of shaft: 12.0 mm
- total length: 19.0 mm



■ **UVB-150T**

**UV Battery Lamp 4 W with Torch**

Simple UV lamp with PVC suction cup to fix on the glass and integrated torch. Requires 4 batteries size AA (not included).

Wavelength 315-400 nm



■ **LR-150**

**Replacement Tube 4W BLB for UVB-150 and UVB-150T**

dimensions:

- length: 133 mm
- diameter: 16 mm
- wavelength 315-400 nm



■ **LRW-150**

**Replacement Tube 4W BL for UVB-150 / UVB-150T**

dimensions:

- length: 133 mm
- diameter: 16 mm
- wavelength 315-400 nm



■ **GKL-868**

**UV Led Lamp 4 W**

- four small PVC suction cups for safe fixation on the glass
- 8 W high-power UV LED for very short curing times



■ **UVA-200-LED LED UV Lamp 2 W (12V)  
for power outlet/cigarette lighter**



- two small PVC suction cups for safe fixation on the glass
- 2 W LED for very short curing times\*
- NOTE: Not suitable for 24V vehicle voltage. Damages because of wrong vehicle voltage are not covered by warranty!
- Wavelength: 365 nm

■ **UVN-200-LED LED UV Lamp 2 W (230V / 50 Hz)  
with Euro plug and 5 m connection cable**



- two small PVC suction cups for safe fixation on the glass
- 2 W LED for very short curing times\*
- Wavelength: 365 nm

\*Besides the UV radiation the real curing time also depends on the used resin. With this lamp all our resins cure in only 60 seconds.

■ **UVA-400-LED ProGlass Universal UV LED Lamp 8 W (12V/24V/230V)**



- Universal UV LED light for all type of vehicles
- two small PVC suction cups for safe fixation on the glass
- 8 W LED for very short curing times\*
- Length: 330 mm
- operation on 12 V and 24 V on-board socket
- operation on a 230 V socket using an adapter
- Wavelength: 365 nm

\* Besides the UV radiation the real curing time also depends on the used resin. With this lamp all our resins cure in only 60 seconds.

■ **UVAA-170-LED ProGlass battery powered UV LED lamp 5V / 8W**



- 8 W high-power UV LED for very short curing times
- This cordless,handy and very efficient UV-Light is perfect for the mobile and stationary use.
- Two small PVC suction cups for safe fixation on the glass
- Scope of delivery includes USB charging cable and 230 V power supply
- Length: 170 mm
- Wavelength: 365 nm

\* Besides the UV radiation the real curing time also depends on the used resin. With this lamp all our resins cure in only 30 seconds.

■ **SL-230V**



**Work Light 8W (230 V / 50 Hz)  
with Euro plug and 5 m connection cable**

Robust work light with electronic ballast (with bright white fluorescent tube - no UV lamp!). With a rotary metal hook.

■ **FSL-450**



**Flexible Suction Mount with Work Light  
450 mm long**

Kit contains:

- 1 flexible suction mount (item no. FSH-450)
- 1 work light 8W (item no. SL-230V)

■ **FSH-450**



**Flexible Suction Mount  
450 mm long**

The suction mount enables you to easily and safely fix a work light on almost every flat surface on a vehicle. Thanks to the flexible arm the lamp can be adjusted easily. With this device you can for example perform windscreen repairs even in poorly lit places.

technical data:

- suction pad-Ø 120 mm
- flexible arm length: 38 cm
- suitable for lamp-Ø of approx. 25-30 mm

■ **URK-420**

**UV & Rain Protection Dome, inner diameter 420 mm**



The UV & rain protection dome protects against harmful UV radiation or rain when carrying out stone chip repairs outdoors, as well as in strong daylight in the workshop. Thanks to the transparent dome shape, the repair can be visually and practically monitored at all times.



■ **WZA-4022**

**Tool Tray made of rigid foam**



Everything needed for a windscreen repair will fit into this tool tray. This way you will always have any small parts ready to hand and safely stored at your workplace.

The rigid foam offers a soft surface that will not scratch the paint and is non-skid so that the tray will safely stay on the hood.

outside dimensions (approx.): 47 x 30 x 5.5 cm  
storage space (approx.): 40 x 22 x 4.0 cm



■ **SPF-050-D** **Windscreen Plaster, German package at 50 pieces**

■ **SPF-050-E** **Windscreen Plaster, English package at 50 pieces**

■ **SPF-050-F** **Windscreen Plaster, French package at 50 pieces**



The windscreen plaster is a cost-efficient give away. Many bigger companies in our business have been using it successfully for quite a long time.

Make sure to get your part of the windscreen repair business and hand out the windscreen plaster to as many as possible of your clients.



The front side is neutral and refers to the specialist mentioned at the back side. At the back side you can attach a printed address label or put on your company stamp.

■ **SPF-050-IND** **Windscreen Plaster, designed individually**

Starting from 1.000 pieces we print your individually designed business card with windscreen plaster!

The front side of the business card (printed on 350g offset paper, size 85 x 55 mm) contains some general information about windscreen repair and a peelable windscreen plaster (Ø 34 mm) with your company name and phone number.

The reverse side can be designed completely to your wishes. If you want to include a company logo or if you already have an artwork (e.g. your business card), please send us these files in PDF format. If you provide printable PDF files from your graphic designer you can also individualize the front side. For this purpose please ask for our layout guidelines.



To offer you the best prices this product is produced in combination with orders from other customers. This means that we collect the orders and print them together periodically. Please check the scheduled dates on our website (under item SPF-050-IND). For bigger quantities or special designs we will be happy to submit you an individual quote.



GPF-250

■ GPF-250

**ProGlass Glass Polish**  
bottle at 250 ml, liquid polishing compound

■ GP-1000

**ProGlass Glass Polish**  
box at 1 kg polishing powder, to mix with water  
(makes approx. 1,660 ml liquid polishing compound)

■ GP-5000

**ProGlass Glass Polish**  
bucket at 5 kg polishing powder, to mix with water  
(makes approx. 8,330 ml liquid polishing compound)

ProGlass glass polish, liquid or powder, is a high-quality grinding and polishing product, for surface finishing of glasses. The ingredients are the same used successfully in the glass industry to remove scratches and to polish glass surfaces.

For scratch removal we recommend to use a polishing machine or an orbital grinder.

Fine scratches, transport defects, traces from the suction cup lifter, coatings and resistant dirt can also be removed by hand. For that please use a clean cotton cloth, a lint-free tissue, a cloth to polish varnish or anything similar.

**Features:**

- reliable deep cleaner for the vehicle replacement glazing (**removes all oil, grease and silicone residues**)
- perfect pre-cleaner for thorough cleaning before applying a water repellent or to fully remove any previously applied coatings
- high-quality polishing agent to remove scratches on the glass surface (e.g. caused by windscreen wipers, ice scrapers, cleaning sponges or similar things)
- simple and safe application
- inoffensive to varnishes, plastics and rubber parts
- for hand and machine polishing



GP-1000



GP-5000

■ XP-050

**QUIXX Scratch Remover**  
tube at 50 g, for acrylic and plexiglass

QUIXX is a low cost solution for scratched backlights, caravan windows, boat windows, motorcycle windscreens and helmet visors. Easy application by hand or with the machine - use the soft sponge to avoid holograms. Not applicable on polycarbonate!





■ **AP-12E-MW** Milwaukee Angle Polisher, 230 V / 1200 W



Combining ergonomic comfort with powerful performance and outstanding durability, this 230V / 1200W maximum power polishing/sander will get the job done. As a polishing/sander, this tool can be used with 150 mm felt or foam, and glass polish to remove scratches from the windshield, or a backing pad for removing paint or rust from metal, plastic, or fiberglass surfaces. The tool is one of the lightest in its class and has an angled rear handle and side handle for more increased user comfort. A two-finger trigger switch, three-position side handle and conveniently located spindle lock also contribute to the user's comfort.



■ **PPS-170-G** ProGlass Cling-fit Polishing Sponge, coarse



Fine-pored medium polishing sponge (blue) for high stock removal rate. Using it with our glass polish, please take into account that a new sponge absorbs a lot of polish. Only after reaching a certain saturation it will be effective.



■ **PPS-170-M** ProGlass Cling-fit Polishing Sponge, medium



Fine-pored medium polishing sponge for high stock removal rate. Using it with our glass polish, please take into account that a new sponge absorbs a lot of polish. Only after reaching a certain saturation it will be effective.



■ **PFW-075** Cling-fit Polishing Felt, hard, Ø 75 mm x 5 mm (white)

■ **PFW-150** Cling-fit Polishing Felt, hard, Ø 150 mm x 5 mm (white)

The polishing felt is especially good for faster removal of deeper scratches in a small area. Using it with our glass polish the felt will be saturated much faster than a sponge.

**■ FPS-128****Felt Polishing Disc 100 x 28 mm****■ FPS-142****Felt Polishing Disc 100 x 42 mm**

With this, through its density and purity, high-grade polishing wheel you are able to remove scratches, marks and staining from any glass surface.

We advise to use in combination with glass polish to achieve more positive results. The polishing wheel stands out due to a very low abrasion which results in a very long service life. To be used with an electrical or cordless drill (speed up to 3000 rpm).

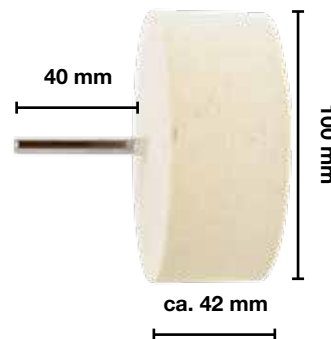
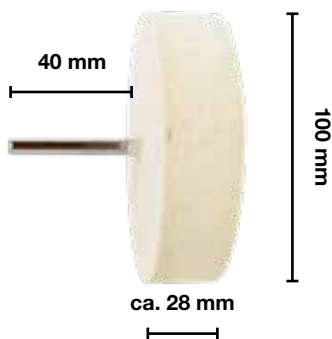



- SAS-340
- SAS-340-B



SAS-340

**Sehen Ihre Scheinwerfer so aus?**  
 schlechte Sicht bei Nacht - erhöhtes Sicherheitsrisiko  
 unansehnliche Optik - kein TÜV!!!



**Wir bieten eine günstige Lösung!**

Mit dem ProGlass Scheinwerfer-Aufbereitungssystem werden die durch UV-Strahlung und Umwelteinflüsse vergilbten und ermatteten Scheinwerfergläser aus Kunststoff wieder wie neu!

- geeignet für alle Kunststoffgläser (konventionelle Streuscheibe und Klarglas-Design)
- erspart Ihnen den mehrere 100 € teuren Austausch der kompletten Scheinwerfer
- aufbereitete Scheinwerfer sind für mindestens 2 Jahre gegen die erneute Verwitterung der Kunststoffgläser geschützt

- wieder optimale Sicht
- mehr Fahrsicherheit
- verbesserte Optik
- kostengünstige & schnelle Methode



**Headlight Restoration Kit Full Set in plastic case**

**Headlight Restoration Kit Starter Set without case**

Plastic headlight lenses (polycarbonate) deteriorate with age and become yellow opaque. The brightness of the light is reduced and the risk of accidents during night driving is increased.

With this professional system for the restoration of weathered plastic headlight lenses, you can offer your customers an economical and ecological alternative rather than replace the whole headlight.

The system comes in a foam-lined plastic case, so that all components are properly maintained.

In addition to the parts and materials in the system, you only need a cordless drill (for example Item No.: ASM-M12), tape (to protect the adjacent parts of the vehicle), a spray bottle with clean water and cleaning paper.

**Features:**

- suitable for all plastic headlight lenses (standard design and transparent)
- low cost of consumables for each headlight
- needed work-time for each headlight only about 30 minutes
- saves your customers the expensive replacement of the whole headlight
- lights treated with this system are protected against weathering of the plastic lenses for at least 2 years \*
- profitable additional business for workshops, car glaziers, vehicle conditioners, dealers of used cars, etc.

\* determined at specific long-term tests with different vehicles



SAS-340-B

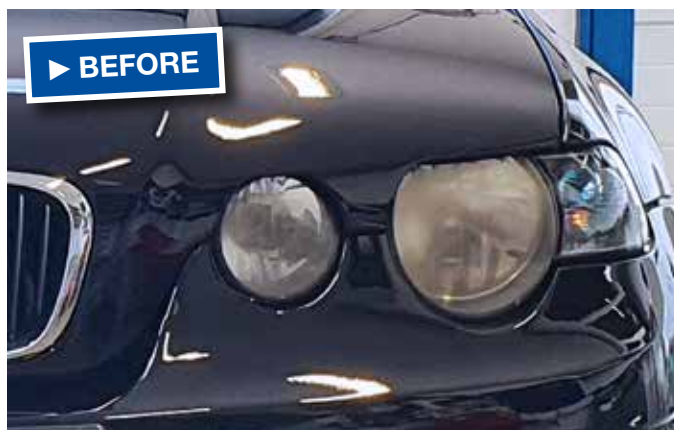

### **SAS-340 Kit contains:**

- 1 disc sanding pad 76.2 mm with adaptor for cordless drill SAT-762
- 1 interface pad soft, 76 mm STS-076
- 1 polishing pad abrasive, 80 mm SSG-080
- 1 polishing pad fine, 76 mm SSF-076
- 20 sanding disc grit 500 SLS-500 (pkg at 10)
- 20 sanding disc grit 800 SLS-800 (pkg at 10)
- 10 sanding disc grit 1500 SLS-1500 (pkg at 5)
- 6 sanding disc grit 3000 SLS-3000 (pkg at 5)
- 1 Polish, 235 ml SAP-235
- 1 Finish, 235 ml SAF-235
- 1 instruction manual, english
- 100 flyer DIN long (German) SAS-340-F (pkg. unit=100)
- 1 showroom poster DIN A1 (German) SAS-340-P
- 1 foam lined plastic case, approx. 34 x 27.5 x 8.3 cm

### **SAS-340-B Kit contains:**

- 1 disc sanding pad 76.2 mm with adaptor for cordless drill SAT-762
- 1 interface pad soft, 76 mm STS-076
- 1 polishing pad abrasive, 80 mm SSG-080
- 1 polishing pad fine, 76 mm SSF-076
- 10 sanding disc grit 500 SLS-500 (pkg at 10)
- 10 sanding disc grit 800 SLS-800 (pkg at 10)
- 5 sanding disc grit 1500 SLS-1500 (pkg at 5)
- 5 sanding disc grit 3000 SLS-3000 (pkg at 5)
- 1 Polish, 235 ml SAP-235
- 1 Finish, 235 ml SAF-235
- 1 instruction manual, english
- 100 flyer DIN long (German) SAS-340-F (pkg. unit=100)

The starter set has a reduced scope of delivery, but besides that it uses the same high-quality components than the full set SAS-340.

**■ STS-076****Interface Pad soft, Ø 76 mm**

Soft interface pad as a compensating interface for the sanding discs SLS-500, SLS-800, SLS-1500 and SLS-3000. With hook and look fixture.

**■ SLS-500****Sanding Disc Grit 500, Ø 75 mm,  
package at 10 pieces**

Sanding discs with hook and look fastening for headlight restoration.

**■ SLS-800****Sanding Disc Grit 800, Ø 75 mm,  
package at 10 pieces**

Sanding discs with hook and look fastening for headlight restoration.

**■ SLS-1500****Sanding Disc Grit 1500, Ø 75 mm,  
package at 5 pieces**

Sanding discs with hook and look fastening for headlight restoration.

**■ SLS-3000****Sanding Disc Grit 3000, Ø 76 mm,  
package at 5 pieces**

Sanding discs with hook and look fastening for headlight restoration.



■ **SAP-235**

**Polish for the Headlight Restoration  
bottle at 235 ml**

Specialized polishing compound for the headlight restoration.

No polish for car finishes - do not use on painted surfaces!

Does not contain siloxane!



■ **SSG-080**

**Polishing Pad Abrasive (orange)  
Ø 80 mm**

Hard polishing pad with dense structure, for hook and look fastening.



■ **SAF-235**

**Finish for the headlight restoration  
bottle at 235 ml**

Specialized polishing compound for the headlight restoration.

No polish for car finishes - do not use on painted surfaces!

Contains siloxane (4-12%).



■ **SSF-076**

**Polishing Pad Fine (grey)  
Ø 76 mm**

Soft polishing pad with fine structure, for hook and look fastening.



■ **SAT-762**

**Disc Sanding Pad Ø 76.2 mm with adaptor for cordless drill**

Disc sanding pad with hook and loop fixture for the headlight restoration system SAS-340 / SAS-340-B. With connection thread 5/16" x 24UNF and screwable adaptor for cordless drill.



■ **SAS-340-F**

**Flyer for Headlight Restoration packing unit: 100 pieces**

The promotional flyer contains end-user information about the headlight restoration and shows a typical before-after situation. In this flyer it is explained in plain words why do headlights yellow over the years and what are the advantages of the restoration (flyer actually only available in German language).

■ **SAS-340-P**

**Poster „Do your headlights look like this?“ size DIN A1 (59.4 x 84.1 cm)**

Actually only available in German language.







- **CHM-108** **Cut-Resistant Protection Gloves, size M, per pair**
- **CHL-109** **Cut-Resistant Protection Gloves, size L, per pair**
- **CHX-110** **Cut-Resistant Protection Gloves, size XL, per pair**

Pleasing to wear, made of finely knitted fabric with woven in glass fibre and grey PU coating at the inside. Outstanding cutting protection, breathable back side, perfect abrasion resistance, excellent sense of touch.

CE / EN 388 CAT II / 4 4 4 2 (cutting protection level 4!)



- **SSH-108-MW** **High Cut level F Gloves Size 8 (M), per pair**
- **SSH-109-MW** **High Cut level F Gloves Size 8 (L), per pair**
- **SSH-110-MW** **High Cut level F Gloves Size 10 (XL), per pair**



18 gauge material for extra dexterity and total mobility for precise task. Lightweight and thin gloves with polyurethane dipped palm. Excellent breathability and all-day comfort. Nitrile reinforcement between thumb and index finger for more durability. SMARTSWIPE™ fingertips – allows the use of touch screen devices without removing gloves. 5 times washable allowing extended lifetime, cost and waste reduction.

European Certified for cut resistance protection: EN ISO 21420, EN388:2016 (3242B), UKCA, EAC, Ukraine



- **ASS-400-MW** **Protective Sleeves Cut Level E**



High stretch nylon material with 4-way stretch points to fit users' arms. Tapered design, wider on the bicep and tight on the wrist, to fit the natural arm form. Elastic band with non-slip dots on the bicep and stretch wrist cuff to keep the sleeves in place and prevent them from sagging. Breathable and lightweight material provides good dexterity and all-day comfort. Elastic thumb loop avoids pressure points when using gloves. Sun UV rays protection with UPF 50+ according to BS EN 13758-1:2002 +A1:2006 for the covered part of the arms.



European Certified for cut protection: EN ISO 21420, EN388:2016 (3X42E), UKCA



■ **MHM-108**

**Finely Knitted Gloves, non slip, size M, per pair**

■ **MHL-109**

**Finely Knitted Gloves, non slip, size L, per pair**

■ **MHX-110**

**Finely Knitted Gloves, non slip, size XL, per pair**

Gloves pleasing to wear, made of finely knitted fabric - especially permeable to air and with optimum fit. Safe grip, due to the polyurethane coating at the inside. Excellent sense of touch combined with a good hand protection.

CE / EN 388 CAT II / 4 1 3 1



■ **LHM-108**

**Winter Knitted Gloves, size M, per pair**

■ **LHX-110**

**Winter Knitted Gloves, size XL, per pair**

The perfect winter gloves for the workshop and in the auto glass mobile service. Seamless knitted glove with foamed and waterproof crinkle latex coating. Soft and warm, especially used for outside work during the winter season. Thanks to the latex coating these gloves are really non-skid with a secure grip.

CE / EN 388 CAT II / 3 1 4 2 + EN 511 / X 4 X



■ **SHM-108**

**Knitted Gloves, non-slip, size M, per pair**

■ **SHL-109**

**Knitted Gloves, non-slip, size L, per pair**

■ **SHX-110**

**Knitted Gloves, non-slip, size XL, per pair**

High-quality cotton/nylon mix knitted gloves that are comfortable to wear and have an optimum fit. Safe grip, due to non slip dots at the palm. Good sense of touch combined with a high protection against cutting.

CE / EN 388 CAT II / 0 2 4 2

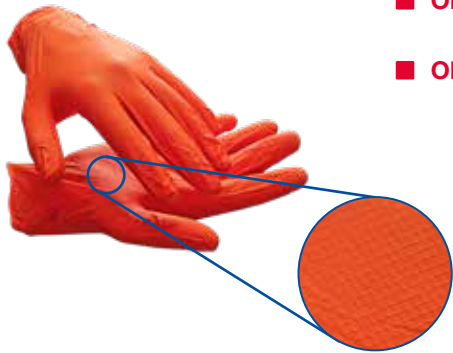
**■ ONG-050L**

**GRIPSTER Nitrile Disposal Gloves, orange, powder-free**  
**Size: L, package at 50 pieces**

**■ ONG-050XL**

**GRIPSTER Nitrile Disposal Gloves, orange, powder-free**  
**Size: XL, package at 50 pieces**

Sturdy and several times usable Nitrile glove. This is possible through a material thickness from 0,15mm at the outside hand up to 0,26 mm at the inside hand.

- Excellent characteristics at handling with resin, primer, oil, grease, cleaning and solvent
- Through his specially fish surface you get a perfect grip even in a wet situation

CE / EN 374

**■ EHN-694**

**Nitrile Disposal Gloves, powder-free**  
**package at 100 pieces**

Nitrile has similar carrying properties than Latex or Vinyl. But it is also resistant against chemicals. Everybody who is doing glass repairs or working with solvents should wear these gloves to protect the skin.

CE / EN 374 / EN 455





■ **BNG-418**

**Nitrile Disposal Gloves, black, powder-free**  
**Size: L, package at 100 pieces**

■ **BNL-820**

**Nitrile Disposal Gloves, black, powder-free**  
**Size: XL, package at 100 pieces**

These gloves have textured fingertips for better handling of small items, are high chemical and puncture resistant, and contain no MBT or Latex. They have an unsurpassed comfort and have no offensive odor.

CE / EN 374 / EN 455



■ **EHV-500**

**Vinyl Disposal Gloves, powdered,**  
**package at 100 pieces**

Vinyl is stretchable and tearproof similar to latex. Therefore it is a perfect solution for persons with latex allergy.

CE / EN 455



■ **EHL-652**

**Latex Disposal Gloves, powder-free**  
**package at 100 pieces**

Powder-free gloves are particularly suitable for touching the glass edges without leaving traces. No negative impact on adhesion.

CE / EN 374 / EN 455



■ **SB-886**

**Safety Goggles**

Unbreakable goggles made of transparent polycarbonate (PC). The ear pieces can be adapted individually due to the very pliable material. The goggles are shaped in a style that will fit over the most spectacle frames.



European Certification: EN 166

■ **SBE-920**

**Safety Glasses**



Sporty clear safety glasses, UV protection 400, scratch-proof, anti-fog, PC 2 mm viewing glass, in length and inclination adjustable holder, nonslip, perfect fit, bulletproof until 45 m/s, usable for all mechanical risk, sport, leisure. Optimal at normal lighting conditions.

European Certification: EN 166 / EN 170 / EN 172

■ **SBK-900-MW** **Enhanced Safety Glasses Clear**

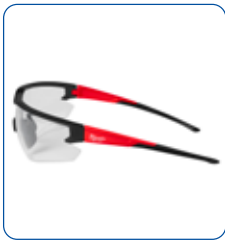

Our Anti-Scratch Safety Glasses are designed for all day comfort with anti-scratch lenses. This protective eyewear has an anti-scratch hard coat to protect the lenses from the demands of the jobsite. The safety glasses feature comfortable temple arms designed for extended wear. These protective glasses have an integrated flexible nose bridge, providing you with extended comfort. Our Anti-Scratch Safety Glasses allow you to see what's important without sacrificing protection.

European Certification: EN 166 / EN 170 / EN 172

■ **SBM-900-MW** **Magnified Safety Glasses Clear +2,5**



Magnifying lenses eliminate the need to wear additional eyewear under your safety glasses. Our Anti-Scratch Safety Glasses are designed for all day comfort with anti-scratch lenses. This protective eyewear has an anti-scratch hard coat to protect the lenses from the demands of the jobsite. The safety glasses feature comfortable temple arms designed for extended wear. These protective glasses have an integrated flexible nose bridge, providing you with extended comfort. Our Anti-Scratch Safety Glasses allow you to see what's important without sacrificing protection.

European Certification: EN 166

■ **SBP-900-MW** **Safety Glasses**

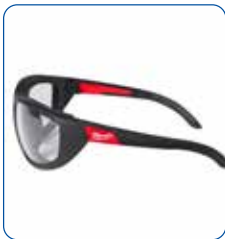

Our Premium Safety Glasses with Gaskets provide Advanced Protection with Ultimate Performance. The safety glasses feature a removable gasket that protects your eyes against debris. For added protection, the lenses are high-velocity impact tested providing you with military grade impact protection. The protective eyewear features fog-free lenses so the lenses will stay clear and unobstructed on any jobsite. Durable anti-scratch lenses protect your eyes while withstanding the demands of a job site.

European Certification: EN 166 / EN 170 / EN 172

The image shows the interior of a car with grey seats and a dashboard. A dark blue workshop cover with a red border and the 'ProGlass' logo is draped over the passenger seat and the inner door panel. The cover is made of a heavy, textured material. The text is overlaid on the right side of the image.

## **ProGlass Workshop Covers**

While working on a customer's vehicle it is not only important to perform a proper repair, but also to avoid secondary damages. Therefore the vehicle should be protected anytime from any unnecessary risk best possible.

Our workshop covers protect the vehicle's interior and exterior in an optimum way. The new Wing Protector covers doors and wings – thus exactly the area in which a technician could get in touch with the varnish – to protect this area particularly well. The non-skid Car Covers also prevent from scratching the varnish or the dashboard. At the same time they offer a safe depot for tools and small parts. The Seat Covers protect the vehicle's interior from soil and damage, depending on the model only the two front seats or the whole front passenger area.

All our workshop covers are made from high-quality components and sewn in manual production in Germany. The outcome of this is durable and hard-wearing products – made for the professional use. In the production we set a high value on accurately positioned and neatly processed seams. In all strained areas, like e. g. the practical hangers, we even use double seams.

This is really visible quality - for products that last for a long time.

■ **KFS-150**

**ProGlass Wing Protector 150 x 50 cm**



A workshop cover for wings and doors with very flexible mounting options. This unique cover is suitable for all magnetic and non-magnetic car bodies.

Thanks to the various mounting options this wing protector can be used on all different kind of cars! It can be fixed to the vehicle with the integrated magnetic tape, by hanging into the clearance between wing and hood or into the door window opening, with the cords at the upper corners to screws, holes or in door seals, with center cords and stopper at side mirrors.

**Advantages:**

- no risk of scratching the painting
- quick and easy handling thanks to the flexible mounting options
- professional appearance towards the customer

**Properties:**

- the fabric (Nylon 70D) is hard-wearing, persistent and water-repellent
- skidproof, cushioned reverse side (5 mm thick non-slip mat)
- magnetic tapes for safe mounting on steel bodies
- plug-in tongues for easy mounting to car body clearances
- cords for variable mounting to screws, holes or in door seals
- all materials are colour-fast and light-resistant
- the cover is washable by hand (please do not clean in a washing machine because of the magnetic tapes and the cords)
- high-quality manufacturing - made in Germany
- available with individual logo in small quantities



■ MHS-180

**ProGlass Bonnet Protector 180 x 65 cm**

A workshop cover for bonnets and rear lids with magnetic fixing.

The evenly rounded side of this cushioned cover protects the bonnet's edge as well as the neighbouring body area. Thanks to the integrated magnetic tapes the cover even stays in place when the bonnet is opened. By that the vehicle's body is protected in the best way and during the whole working process.

**Advantages:**

- no risk of scratching the painting
- quick and easy handling thanks to the integrated magnetic tapes
- professional appearance towards the customer

**Properties:**

- the fabric (Nylon 70D) is hard-wearing, persistent and water-repellent
- skidproof, cushioned reverse side (5 mm thick non-slip mat)
- magnetic tapes for safe mounting on steel bodies
- all materials are colour-fast and light-resistant
- the cover is washable by hand (please do not clean in a washing machine because of the magnetic tapes)
- high-quality manufacturing - made in Germany
- available with individual logo in small quantities





■ **ESS-075**

**ProGlass Single Seat Cover**

Seat cover for covering one front seat.

**Advantages:**

- no glass pieces or dirt on the seats and on scratch-sensitive surfaces
- less dirt means less time for cleaning = time saving
- professional appearance towards the customer

**Properties:**

- with practical hanger loop for clean storage when not in use
- the fabric (Nylon 70D) is hard-wearing, persistent and water-repellent
- the reverse side is skidproof thanks to a soft PVC coating
- all materials are colour-fast and light-resistant
- the cover is fully washable
- high-quality manufacturing - made in Germany
- available with individual logo in small quantities

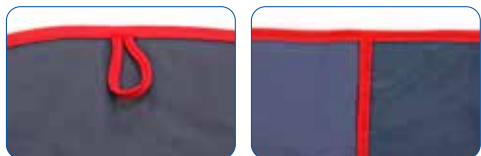

■ **ABS-140**



**Dashboard-Cover 142 x 50 cm**

Protective mats with a skidproof, cushioned reverse side for covering and protecting dashboards.



**Advantages:**

- no risk of scratching, damaging and contamination
- quick and easy handling
- safe and practical place to deposit hand tools on a vehicle
- professional appearance towards the customer

**Properties:**

- the fabric (Nylon 70D) is hard-wearing, persistent and water-repellent
- skidproof, cushioned reverse side (5 mm thick non-slip mat)
- all materials are colour-fast and light-resistant
- the cover is fully washable
- high-quality manufacturing – made in Germany
- available with individual logo in small quantities

■ FZS-120

■ FZS-80



### ProGlass Car Cover 120 x 50 cm

### ProGlass Car Cover 80 x 45 cm

Protective mat with a skidproof, cushioned reverse side for covering and protecting hoods, fenders or dashboards.

#### Advantages:

- no risk of scratching the painting (fender covers with magnets can easily cause small scratches and dents)
- quick and easy handling (no more time-consuming masking of hood and fender edges with tape)
- safe and practical place to deposit hand tools on a vehicle
- professional appearance towards the customer

#### Properties:

- with practical hanger loop for clean storage when not in use
- the fabric (Nylon 70D) is hard-wearing, persistent and water-repellent
- skidproof, cushioned reverse side (5 mm thick non-slip mat)
- all materials are colour-fast and light-resistant
- the cover is fully washable
- high-quality manufacturing - made in Germany
- available with individual logo in small quantities

## Customized Covers

Starting from a quantity of only 10 pieces (assorted) we can offer all our workshop covers with your own logo print.

Please contact us for further details and we will provide you an individual quote adjusted to your needs!



■ **LSS-200**

**Wheel and switch knob cover set**

Wheel and switch knob cover set for covering and protecting wheel and knob



**Advantages:**

- no risk of dirt or damage
- less dirt means less time for cleaning = time saving
- professional appearance towards the customer

**Properties:**

- the fabric (Nylon) is hard-wearing, persistent and water-repellent
- all materials are colour-fast and light-resistant
- the cover is fully washable at 50°

■ **TSP-292**

**Equalizer TightSpot Paint Protector set of 2 pieces**



Sometime you have to park cars so close together that the open door could damage the next vehicle. When this happens you need a Set of TightSpots. They are made of dense foam rubber block and a vacuum cup that holds the block in the right position.

■ **KSM-4732**

**Knee protection pad 470 x 320 x 35 mm**

Knee protection pad made of EVA foam for articular and body gentle working on deep and inaccessible spots.



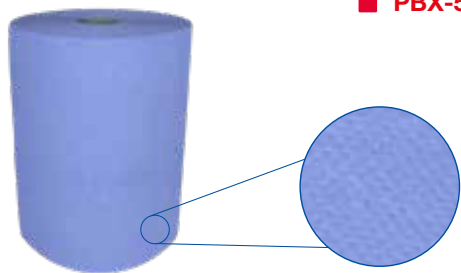

**■ PBX-538****Paper Towel, 2-ply paper, blue, industrial quality  
approx. 500 towels 38 x 38 cm**

Two-ply paper towel with glued plies for higher volume and better suction.

**■ PWH-400****Paper Roll Holder, wall-mounted**

Wall mounted paper roll holder, made of blue lacquered steel pipe, galvanised steel sheet and plastic.

**■ PBS-400****Paper Roll Holder, free-standing**

Free-standing paper roll holder, made of blue lacquered steel pipe, galvanised steel sheet and plastic.

**■ PBT-050****Special-Cleaning Cloth 1-ply, turquoise**

The cleaning cloth is optimally suitable for a free of residues and a lint free application.

- Lint free
- Tear-resistant
- Wet-strength
- Absorbent
- Washability
- Reusable



■ **RS-7030**

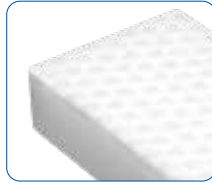

### **Cleaning Sponge, 100 mm x 70 mm x 30 mm**

Cleaning sponge for cleaning screen printing edges. Removes streaks, calcification, label residues and other soiling on glass and smooth surfaces. The sponge can be used dry or damp.

■ **MFT-3530**



### **ProGlass Microfibre Cloth warp knitted, 35 x 30 cm**

Microfibre cloth in looped knitting style (warp knitted) for fast cleaning of light and heavy structured surfaces, like e. g. dashboards and linings. The cloth is also suitable for the cleaning of glass surfaces. Washable up to 90°C.

■ **GTU-4040**



### **Glass Cloth made of microfibre, fine woven, 40 x 40 cm**

Smoothly knitted, small meshed cloth made of finest microfiber for effortless cleaning of all glass surfaces. Removes greasy contamination mostly with a single wipe. Washable up to 90°C.

■ **SFL-3738**



### **Synthetic wash-leather 37 x 38 cm**

Synthetic wash-leather for streak-free cleaning of windscreens, glasses, mirrors, headlights and car bodies. For all smooth surfaces where quick drying without residue is desired after cleaning. Very good alternative to cleaning paper for washability and long life! High cleaning power without detergents.



■ **XL-050**

**Quixx Varnish-Scratch-Remover**

The Varnish Scratch Remover removes scratches, small scratches and traces of colour quickly, effectively and reliably from all shiny and metallic varnishes.



■ **LPR-500**

**ProGlass Universal Polish  
bottle at 500 ml**

Universally applicable polishing compound to refresh a weathered car finish, to polish light scratches (good filling properties) or glue residues (e. g. after removing a vehicle labelling).

Long-lasting protection and care for every car finish.



■ **SRS-500**

**ProGlass Active Glass Cleaner  
500 ml aerosol can**

**Features:**

- firmly active foam with excellent stain removing power
- dissolves and removes effortlessly all kind of dirt like insects, dust from the road, nicotine film, oil and grease from auto glasses, mirrors and painted surfaces
- also suitable for cleaning painted surfaces as well as rubber and plastic parts on vehicles
- high active ingredient, therefore more profitable than many other products on the market
- sprayhead system with narrow spray angle for easy reach into edges and corners
- silicone-free and gentle

**Note:**

Do not spray on hot surfaces. Not suitable for polycarbonate glass.

Only available in packing units of 12 pieces.



■ **SFL-1000**

**Spray Bottle with standard sprayer  
capacity 1.0 litre**

Transparent plastic bottle with a capacity of 1,000 ml, for glass cleaner, soapy water and other non-corrosive liquids. Due to the adjustable plastic spray nozzle you will obtain any desired result from atomised spray to a strong jet of water. For transport the nozzle can be locked.

Spray output: 1 ml ± 0,1 ml



■ **SFM-1000**

**Spray Bottle with professional sprayer  
capacity 1.0 litre**

Transparent plastic bottle with a capacity of 1,000 ml, for glass cleaner, soapy water and other non-corrosive liquids. Due to the adjustable plastic spray nozzle you will obtain any desired result from atomised spray to a strong jet of water. For transport the nozzle can be locked. The trigger head is extremely robust and long-lasting and has a big output.

Spray output: 1.1 ml ± 0,2 ml



■ **SFC-1000**

**Spray Bottle, professional quality, with FKM seal for use with  
aggressive liquids, capacity 1.0 litre**

The spray bottle made of transparent plastic holds one liter of liquids and is also suitable for aggressive agents. The adjustable plastic nozzle delivers any desired spray pattern from finely atomized to a powerful jet and can also be turned off completely for transport. The professional spray head is extremely robust and durable and has a large output.

Spray output: 1.15 ml ± 0.15 ml



■ **DPZ-1500**

**Compressed Air Sprayer, professional quality  
capacity 1.5 litre**

White, transparent plastic container with a capacity of 1,500 ml, for glass cleaner, soapy water or other non-corrosive liquids. Put container under pressure, using the integrated manual pump. To spray, you only need to push the thumb lever. This type of spray bottle is perfect when a large amount of liquid is needed, e.g. to install window films. The handle is ergonomical shaped, comfortable handling even for frequent use. Due to the adjustable brazen spray nozzle you will obtain any desired result from atomised spray to a strong jet of water. For transport the nozzle can be locked.

■ **HRT-150**



**ProGlass Hand Cleaning Towels dispensing bucket at 150 towels (approx. 28 x 28 cm)**

The wet cleaning towels are perfect to remove even resistant dirt, on the way (in service vehicles, busses or lorries) but also at the work place where quick cleaning is required. Within seconds, fat, oil, grease, primer or auto glass adhesive will be removed. The towels have an agreeable odour and they are eudermic. Suitable to clean tools and all other colourfast and water compliant surfaces, such as many plastics, seat covers, roofliners, interior linings and varnished surfaces.



■ **HRT-072**



**SCRUBS-IN-A-BUCKET Hand Cleaning Towels dispensing bucket at 72 towels (ca. 27 x 31 cm)**

Mobile and very effective hand cleansing and tool cleaning system. Removes quickly, thoroughly and gently without water strongest dirt like grease, oil, glue, tar, wax, soot, paint, ink, sealant, polyurethane, etc. After cleaning your hands the towels retain enough cleaning power left for the effective cleaning of tools and equipment.

The towels are tintured with a special cleaning agent,

Napped side removes stubborn soils. Smooth side for gentle hand cleansing. The product is antibacterial, doesn't strip the skin's natural oils, and is biodegradable.

The single towels are micro-perforated and can be taken from the bucket easily. SCRUBS-IN-A-BUCKET belongs into every service vehicle and are especially useful for mobile auto glass jobs!



■ **HRT-090**

**ProGlass Hand Cleaning Towels  
dispensing bucket at 90 towels (approx. 27 x 31 cm)**

Mobile and very effective hand cleansing and tool cleaning system. Removes quickly, thoroughly and gently without water strongest dirt like grease, oil, glue, tar, wax, soot, paint, ink, sealant, polyurethane, etc. After cleaning your hands the towels retain enough cleaning power left for the effective cleaning of tools and equipment.

The towels are tintured with a special cleaning agent,

Napped side removes stubborn soils. Smooth side for gentle hand cleansing. The product is antibacterial, doesn't strip the skin's natural oils, and is biodegradable.

The single towels are micro-perforated and can be taken from the bucket easily. ProGlass Hand Cleaning Towels belong into every service vehicle and are especially useful for mobile auto glass jobs!

Bucket from 100% PCR (Recycled material)



■ **HRT-001**

**ProGlass Hand Cleaning Towel  
22 x 20 cm singel**

Mobile and very effective hand cleansing towel. Removes quickly, thoroughly and gently without water strongest dirt like grease, oil, glue, tar, wax, soot, paint, ink, sealant, polyurethane, etc. After cleaning your hands the towel retain enough cleaning power left for the effective cleaning of tools and equipment.

The towel are tintured with a special cleaning agent. Napped side removes stubborn soils. Smooth side for gentle hand cleansing. The product is antibacterial, doesn't strip the skin's natural oils, and is biodegradable.

The ProGlass Hand Cleaning Towel belongs into every vehicle and is especially useful for mobile jobs!

■ **HBP-220**



**Hand brush made of polyethylene**

Hand brush for cleaning the dashboard and other parts of the interior after windscreen removal. Brush with closely graded bristle from polyethylene, hard-wearing and washable.



■ **RHB-160**



**Hand brush made of horsehair**

Hand brush for cleaning the dashboard and other parts of the interior after windscreen removal. Brush with closely graded bristle from horsehair, hard-wearing and washable.



■ **VFX-2023**



**Vacuum Attachment Set**

Adapter set for vacuum cleaners for four different pipe diameters. The set includes 1 pipe and 4 different hoses that can be adapted to each other to cover the widest possible range of applications. With this set, even hard-to-reach areas on vehicles can be cleaned without any problems.



■ ASS-F18



### FEIN Battery Wet / Dry Vacuum cleaner 18 Volt

The rotation airflow ensures strong uninterrupted throughput with all time low dust formation and a clean working environment. Different accessories and operate without a dust bag offer several wet and dry application. The compact design and a low weight make the transport easy for all operational area. Compatible with all AMPShare 18 V interface, also with the 18 V BOSCH Professional battery-interface.

- 1 FEIN Vacuum cleaner 18 Volt
- 1 Tool-Adapter
- 1 Crevice nozzle
- 1 Floor nozzle
- 1 Hose
- 1 Distributor pipe
- 1 Suction tube set 3 pc.
- 1 Flat pleated filter PES
- 1 Roller-Set 4-pieces
- Attention! Machine supplied without battery and charger

■ ANT-M18



### Milwaukee Wet / Dry Vacuum Cleaner 18 Volt

The very powerful cordless vacuum cleaner is ideal for mobile use and on-site glazing.

- Built-in blower: provides 21 l/sec of air flow for maximum efficiency
- Wet/Dry using without filter exchange
- Stackable tool box design: for added portability and easier storage
- Flexible battery system: works with all Milwaukee® M18™ batteries (18V Cordless Caulking Gun)
- Supplied with washable filter, hose, crevice tool and utility nozzle
- Not usable for toxic and inflammable fluid
- HEPA rated 99.7 % high efficiency wet/dry filter: for fine dust collection
- **Attention!** Machine supplied without battery and charger.



■ **FSD-025L-SET Fein Extractor Dustex 25 L with Accessory Set**

Compact, powerful wet and dry dust extractor for connecting to power tools when working in the workshop and for assembly work, with accessory set FSD-25L-Z.

Technical data:

- Powerful turbine for 70 l/s volumetric flow and 253 mbar vacuum (240V)
- Low noise level of 67 dB (A).
- Large range thanks to 6 m power cable and 4 m suction hose.
- Large, 360° rotating castors for optimum manoeuvrability even in tight spaces.
- Tool collar with suction force regulation to set the suction power with ease.
- Auto start socket with switch-on delay to avoid power surges.
- Practical storage area with edge.
- Approval for dust class L.

■ **FSD-025L Fein Extractor Dustex 25 L**

Extractor with suction hose (length 4 m, Ø 35 mm), tool collar with suction force regulation, 1 Fleece filter bag and 1 Flat-fold filter cellulose.



■ **FSD-025L-Z Fein Dustex 25 L Accessory Set**

Kit contains:

- 2 suction pipes (metal)
- 1 combi nozzle with interchangeable inserts
- 1 groove nozzle
- 1 suction brush
- 1 elbow



■ **FDB-025L Filter bag for DUSTEX 25 L, pack of 5 pieces**

## Index by Item Numbers

Item No.	Item No.	Item No.	Item No.	Item No.	Item No.	Item No.			
2P1021	156	ASS-400-MW	300	CRK-109	277	EDS-150	29	FSD-025L-Z	320
401	201	ASS-F18	319	CRK-150	277	EDS-150-0	29	FSD-210-MW	97
1942	268	ATG-5050	207	CS-696	80	EHB-186	63	FSH-450	287
2496	268	ATO-100	54	CT-318	155	EHL-652	303	FSK-003	112
4850	201	ATV-2012	62	CZ-540	80	EHN-694	302	FSK-150	106
51847	53	AV-418	155	DBP-1824-WSP	14	EHV-500	303	FSK-300	106
51848	53	AV-435	156	DBP-3316-WSP	14	EMS-055	253	FSK-213	112
51849	53	BA-MIGNON	279	DBP-3725	30	EPS-761	97	FSL-216	112
AB-10	118	BFE-1400	63	DBP-4024-WSP	14	ES-1406	62	FSL-219	112
AB-10S	118	BHS-058	98	DBP-4525	30	ESS-075	308	FSL-450	287
AB-50S	118	BK-230	114	DBP-4530-SET	30	ESS-150	21	FSS-213	112
ABB-50	118	BK-315	114	DBP-6030	30	EWA-1702	91	FSS-216	112
ABK-10	120	BMA-300-MW	182	DBP-6030-S	30	EWS-620	246	FSS-219	112
ABS-025	166	BMA-500-MW	182	DD-02	25	FB-072	59	FTL-402	220
ABS-140	308	BMR-1488	89	DD-50	25	FB-073	59	FTL-402-1	220
AC-325	155	BN-308	90	DFS-100	32	FB-076	59	FTL-430	220
AC-625C	155	BN-326	90	DG-322	54	FB-079	59	FTL-430-1	220
ADR-300	28	BN-408	90	DGH-300	33	FB-081	59	FWB-10	118
AFSC-22	56	BND-2882	90	DGL-200	34	FB-101	59	FZS-80	309
AFSC-22-A	56	BNG-418	303	DGL-201	34	FB-107	59	FZS-120	309
AGD-0505	159	BNL-820	303	DGL-201S	34	FB-110	59	GBZ-200	216
AGQ-1265	158	BNZ-2685	90	DGL-201TS	21	FB-123	60	GBZ-225	216
AGR-1105	157	BP-036	152	DGS-301	33	FB-157	60	GC-130	216
AGT-1105	157	BP-180	151	DH-280	31	FB-174	60	GCK-119	217
AGV-0906	158	BP-184	151	DHH-5836	82	FB-176	60	GCM-130	217
AGV-1310	159	BP-472	153	DHL-300	33	FB-194	60	GH-738	215
AGV-5449	159	BP-AFSC-22	56	DHS-360	82	FB-207	60	GH-749	215
AKP-036	152	BP-M12	152	DHS-500	82	FB-208	60	GH-753	215
AKP-075/L-01	153	CDZ-195	80	DLH-511	87	FB-209	60	GHK-140	214
AKP-472	153	CE-119	78	DLR-160	54	FB-210	61	GHK-280	214
AKV-2515	160	CE-175	79	DM-1094	162	FB-211	61	GHK-560	89
ALS-185	223	CE-590	79	DNM-3050	181	FB-212	61	GHS-140	214
AM-360-FPS	280	CE-607	79	DP001P00	31	FB-217	61	GHS-280	214
AM-361	280	CE-657	78	DP001P01	31	FBH-190	17	GKL-868	284
AM-361-1	280	CE-749	89	DPZ-1500	315	FDB-025L	320	GMK-300	196
AM-361-LG	280	CEG-148	78	DR-475	269	FDS-700	164	GP-1000	290
AMM-880	103	CEG-1410	78	DR-950	269	FEC-417	57	GP-5000	290
ANL-400-MW	221	CEK-180	81	DRB-140	281	FEC-417Q	57	GPF-250	290
ANT-M18	319	CEK-215	81	DRO-116	261	FEC-417Q-A	58	GPL-154	127
AP-12E-MW	291	CES-125	79	DRV-500	261	FEC-417Q-B	58	GPL-154-1	127
AP-25	163	CES-250	80	DSA-125-1	256	FGR-440	222	GPL-156	127
AP-100	163	CHL-109	300	DSF-075	17	FGS-140	111	GPL-156-1	127
AP-100-B	163	CHM-108	300	DSP-120	218	FIX-080	103	GPL-158	128
AP-2500	163	CHX-110	300	DSP-200	218	FIX-080-P	103	GPL-158-1	128
APL-25	163	CK-2	122	DSP-400	218	FKM-145	106	GPL-166	128
APL-100	163	CKB-2	122	DSP-800	218	FPS-005-N	275	GPL-166-1	128
APL-100-B	163	CKM-007	237	DSP-1000	218	FPS-010	281	GPL-168	128
APL-2500	163	CKM-021	236	DSS-704	28	FPS-128	292	GPL-168-1	128
APM-100-B	162	CMB-165-MW	115	DST-125	35	FPS-142	292	GPL-170	128
AS-115-K	15	CMK-170	119	DST-210	35	FSB-102	61	GPL-170-1	128
AS-150-M	15	CMM-018	237	DST-410	36	FSB-103	61	GPL-190	129
AS-537	274	CMM-175-MW	115	DST-733	36	FSC-120	107	GPL-190-1	129
ASB-001	156	CMS-160-MW	115	DST-745	36	FSC-150	107	GPL-191	129
ASBB-10	118	CMU-099	236	DST-757	36	FSC-300	107	GPL-191-1	129
ASM-M12	19	CP-5040	277	DST-757-WSP	15	FSD-025L	320	GPL-192	129
ASM-M18	19	CRK-075	277	DWR-120	92	FSD-025L-SET	320	GPL-192-1	129

## Index by Item Numbers (continuation)

Item No.	Item No.	Item No.	Item No.	Item No.	Item No.
GPL-192C	129	INJ-M14-KIT	271	KPM-4464	138
GPL-192C-1	129	ISH-691	86	KPM-4464-1	138
GPL-194	130	ISS-009-MW	96	KPM-5010	139
GPL-194-1	130	IWH-692	86	KPM-5010-1	139
GPL-SET	130	JP-135	252	KPM-6260	139
GPZ-225	95	JP-140	252	KPM-6260-1	139
GS-120	110	KA-539	193	KPM-7474	139
GS-380	110	KB-1228	160	KPM-7474-1	139
GT-3516	256	KBA-4915-12	192	KPM-7488	140
GTG-5050	207	KBA-4915-50	192	KPM-7488-1	140
GTU-4040	313	KFB-230	161	KPM-15885	140
GY-025967	185	KFP-050	161	KPM-15885-1	140
GY-026971	186	KFS-150	306	KPM-74132	139
GY-027510	185	KM-130	219	KPM-74132-1	139
GY-029415	186	KM-140	219	KPM-76180	140
H-1	121	KM-150	219	KPM-76180-1	140
HB-5	121	KM-9527	219	KPM-80164	140
HBB-5B	121	KMB-085	282	KPM-80164-1	140
HBP-220	318	KMB-085-1	282	KPR-188	136
HBS-027	85	KMB-105	282	KPR-188-1	136
HK-5	116	KMB-105-1	282	KPR-191	136
HLK-012	101	KMC-085	282	KPR-191-1	136
HOB-1	121	KMC-085-1	282	KPR-194	136
HOK-1	121	KMC-105	282	KPR-194-1	136
HP-1002	198	KMC-105-1	282	KPR-199	136
HRS-100	255	KMK-110	283	KPR-199-1	136
HRT-001	317	KMK-110-1	283	KRS-1588	208
HRT-072	316	KMK-120	283	KS-125	166
HRT-090	317	KMK-120-1	283	KSC-019	224
HRT-150	316	KPA-250	137	KSC-025	224
HWA-2636	91	KPL-154	133	KSK-050	195
HWS-680	246	KPL-154-1	133	KSK-4510	224
HWS-760	246	KPL-166	133	KSK-29190	224
IND-0609	232	KPL-166-1	133	KSM-4732	310
IND-601099	232	KPL-185	134	KSP-1580-12	192
IND-601201	232	KPL-185-1	134	KSP-1580-100	192
IND-601703	234	KPL-189	134	KSP-1580S-12	192
IND-601704	234	KPL-189-1	134	KSP-1580S-100	192
IND-601720	234	KPL-189B	134	KSP-15104-12	192
IND-601721	234	KPL-189B-1	134	KSP-15104-100	192
IND-601723	234	KPL-190	134	KSP-15105V-10	193
IND-601725	234	KPL-190-1	134	KSP-15110D-10	193
IND-601727	234	KPL-192	135	KSR-5025	137
IND-601730	234	KPL-192-1	135	KSX-200	137
IND-601734	234	KPL-192C	135	KSZ-163	194
IND-601756	234	KPL-192C-1	135	KSZ-306	194
IND-601796	232	KPL-193	135	KTO-230	191
IND-602030	233	KPL-193-1	135	KTP-502K	195
IND-602060	233	KPL-197	135	KZS-003-MW	95
IND-603070	235	KPL-197-1	135	L-2	119
IND-603080	235	KPM-3752	138	LB-10	120
IND-607703	234	KPM-3752-1	138	LB-50B	120
IND-611071	234	KPM-4151	138	LB-300	102
IND-611074	234	KPM-4151-1	138	LBB-10	120
INJ-007-DI	271	KPM-4169	138	LBB-50	120
INJ-M14-F	271	KPM-4169-1	138	LEC-175F	83
				LEC-175FL	83
				LEC-175FV	83
				LEC-175FZ	83
				LEC-175G	84
				LEC-175GU	84
				LEC-175GV	84
				LEC-SET1	83
				LEC-SET2	84
				LED-LIGHT	220
				LEM-4000	181
				LH-230	87
				LHK-160	87
				LHM-108	301
				LHX-110	301
				LM-460	114
				LM-610	114
				LPR-500	314
				LR-150	284
				LRW-150	284
				LSK-140	199
				LSOL-10	120
				LSS-085	198
				LSS-200	310
				LT-415	213
				LT-415-1	213
				LT-750	213
				LT-750-1	213
				LWB-3B	120
				MAC-1125	32
				MB-743	96
				MB-744	96
				MBR-600	96
				MC-500	276
				MC-1000	276
				MCA-265	201
				MCM-500	276
				MCM-800	276
				MD-085	195
				MD-085-P	195
				MEH-234	63
				MESSER-C	117
				MFT-3530	313
				MH-120	222
				MH-140-WSP	15
				MHD-110	88
				MHF-510	222
				MHK-069	88
				MHL-109	301
				MHM-108	301
				MHP-139	191
				MHS-068	88
				MHS-150	88
				MHS-180	307
				MHX-110	301
				MK-081	194
				ML-101	165
				MLW-455	233
				MR-300	275
				MRH-055	281
				MS-6	111
				MS-180	86
				MS-180-WSP	16
				MS-181	86
				MS-205	81
				MSF-010	261
				MSK-356	222
				MSL-265	81
				MSP-2030	100
				MT-1	118
				MTB-10B	118
				MTG-5050	206
				MTP-3850	206
				MWW-100-MW	182
				NTC-400	117
				NWS-1080	247
				OCC-200E	176
				OCC-300B	171
				OCC-300-E	173
				OCC-300P	171
				OCC-DT01	178
				OCC-DT02	178
				OCC-DT03	178
				OCC-DT04	178
				OCC-DT05	179
				OCC-DT06	179
				OCC-DT07	179
				OCC-ET01	179
				OCC-KLL	181
				OCC-MB01	177
				OCC-RE1	175
				OCC-RE2	175
				OCC-RSS	173
				OCC-RT01	174
				OCC-RT02	174
				OCC-SLR	177
				OCC-ST01	180
				OCC-ST02	180
				OCC-ST03	180
				OCD-375P	169
				OCD-375-SH	169
				OCD-RT02	174
				OCT-400B	172
				OCT-400-E	173
				OCT-400P	172
				OCT-3040G	173
				OCT-ST01	180
				OCT-ST02	181
				OD-20M	55
				OK-50	52
				OK-51	52
				OK-52	52
				OK-53	52

## Index by Item Numbers (continuation)

Item No.	Item No.	Item No.	Item No.	Item No.	Item No.	Item No.	Item No.		
OK-54	52	RAP-F22	22	SD-44	24	SLP-101	212	TAC-1210	204
OK-55	52	RF-050	267	SDK-202	28	SLP-101-01	212	TAC-1910	204
OK-56	52	RFM-683	87	SDM-421	97	SLS-500	296	TAC-2510	204
OK-57	52	RGS-255-MW	100	SFC-1000	315	SLS-800	296	TAC-5005	204
OL-40	117	RH-727	225	SFE-329	63	SLS-1500	296	TAT-1910	204
OM-520	50	RHB-160	318	SFL-1000	315	SLS-3000	296	TB-3006	208
OM-610	50	RHR-410	225	SFL-3738	313	SMB-135-MW	98	TB-3010	208
OMS-520	51	RK-10	275	SFM-1000	315	SMB-260-MW	98	TF-0910	205
OMS-610	51	RK-10HD	275	SFP-10	196	SMK-025	279	TF-1210	205
ONG-050L	302	RK-100A	110	SFP-100	196	SML-040	279	TF-1910	205
ONG-050XL	302	RK-100B	110	SFS-1550	209	SMQ-425	38	TF-2510	205
OP-20F	55	RK-100HD	110	SFT-1025	209	SOL-189	125	THH-540	101
OP-20M	55	RK-8905	111	SFT-1525	209	SOL-192D	125	THH-540-G	101
P6	12	RKK-10	111	SFT-2025	209	SOL-193A	125	TK-10	116
P8	13	RKS-594	194	SFT-2525	209	SOL-193B	125	TKS-100	116
P10	13	RMP-416	95	SFT-3025	209	SOR-199	124	TM-310	154
P-536	274	RMP-416-1	95	SGM-05	249	SP-0010	189	TM-600	154
PBA-1827	151	RMS-105	197	SGM-09	249	SP-025	275	TMA-2010	203
PBS-400	312	RS-1818	162	SGS-05	248	SP-1010	189	TMB-5555-3	202
PBT-050	312	RS-2030	268	SGS-09	248	SPF-050-D	289	TMB-5555-P	202
PBX-538	312	RS-7030	313	SHE-070	253	SPF-050-E	289	TMB-6655-3	202
PCG-120-KF	152	RSL-330	132	SHG-200	256	SPF-050-F	289	TMB-6655-P	202
PCG-180	150	RSS-0819	100	SHL-109	301	SPF-050-IND	289	TMC-5545-3	202
PCG-180-F	148	RT-560	226	SHM-108	301	SPS-012	281	TMC-5545-P	202
PCG-180-FT	148	RW-201	238	SHP-150	250	SPZ-160	33	TMC-6645-3	202
PCG-180-KF	149	RW-205	239	SHP-150-1	250	SPZ-160	95	TMC-6645-P	202
PCG-180-KFT	149	RW-217	240	SHP-200-1	251	SRB-09	109	TM-TN-0022	153
PCG-180-URS	150	RW-239	241	SHP-230-1	251	SRB-12	109	TN-310	154
PES-0165	210	SAB-10	118	SHU-3237	267	SRB-17	109	TN-600	154
PES-2500	210	SAF-235	297	SHV-125-1	252	SRS-500	314	TO-1437	161
PFK-050	145	SAP-235	297	SHX-110	301	SRW-006	248	TO-1437-100	161
PFN-300	145	SAS-340	294	SK-113	112	SSF-076	297	TPB-1910	199
PFW-075	291	SAS-340-B	294	SK-116	112	SSG-080	297	TPB-1925	199
PFW-150	291	SAS-340-F	298	SK-119	112	SSH-108-MW	300	TPC-1910	204
PHL-115-1	255	SAS-340-P	298	SK-1060B	188	SSH-109-MW	300	TPO-3833	206
PHX-150-1	255	SAT-762	298	SK-1060K	188	SSH-110-MW	300	TPO-7691	206
PL-140	221	SB-886	303	SKA-502	126	SSH-290	102	TS-135	14
PLE-160	220	SBE-920	304	SKA-502M	126	SSH-290	165	TSG-400	20
PML-145-1	164	SBK-900-MW	304	SKS-003	113	SSK-790	278	TSG-401	20
PMS-3000	210	SBM-900-MW	304	SKS-1060B	190	SSR-150	278	TSP-292	310
PPS-170-G	291	SBP-900-MW	304	SKS-1060K	190	STG-3850	207	TSP-2550	223
PPS-170-M	291	SC-313	108	SL-015	279	STG-5050	207	TSP-5050	223
PRH-380	230	SC-313E	109	SL-230V	287	STS-032-MW	99	TVB-0333	198
PRS-118	166	SC-316	108	SL-300-S	144	STS-039	99	TWH-500	34
PSG-001	131	SC-316E	109	SL-350-E	142	STS-076	296	TX-APP06.5-OB	183
PSG-001-25	131	SC-318	108	SL-350-ZM1	143	SVR-2	117	TX-APT06.6-OB	184
PSG-004Q	132	SC-320	108	SL-350-ZS1	143	SWA-2316	94	TX-P1291B	184
PSG-004Q-25	132	SC-320E	109	SL-350-ZV1	143	SWS-580	247	TX-P12926	183
PSG-012Q	132	SCA-316	108	SL-350-ZV2	143	SWS-580-01	247	UAZ-1950	94
PSG-MD10	131	SCE-007	108	SLK-17080	235	SWW-880	250	UCC-320	113
PSG-MD10-K	131	SCE-012	108	SLK-235130	235	TAB-0610	205	UCH-319	113
PSH-120-1	254	SCR-006	108	SLK-S-9050	235	TAB-0910	205	UCL-322	113
PSL-150-1	254	SCR-012	108	SLK-S-17080	235	TAB-1210	205	UCS-321	113
PT-321	54	SCR-L	122	SLL-100	221	TAB-1910	205	ULF-481	226
PWH-400	312	SD-02	24	SLN-102	212	TAB-2510	205	ULR-120	32
QT-5050	237	SD-22	24	SLN-102-01	212	TAB-5005	205	ULR-150	32

## Index by Item Numbers (continuation)

Item No.		Item No.		Item No.		Item No.		Item No.	
UMS-437	116	UW-7001-P	44	WK5-S	69	WKTEC-BX	66	WZT-5836	242
UP-100B	200	UW-7002-P	44	WK5ZR-S	70	WPRO6-3IN1-D	146	XKD-02	27
UP-105B	200	UW-7004-P	44	WK5Z-S	70	WPRO6-EA-3	147	XKD-22	27
UP-107B	200	UWE-3	45	WK6-20N	75	WPRO6-INS4	146	XKD-44	27
UP-200	200	UWG-3	45	WK6-25N	75	WRBIS-300K	9	XL-2	119
URK-420	288	UWS-6	45	WK6-40	74	WRD-4RD	18	XL-050	314
USS-190	48	VFX-2023	318	WK6-40N	74	WRD-AD2	17	XN-96	12
UTO-539	193	VIP-1138	22	WK6-L	74	WRD-DPS	18	XP-050	290
UV-528	274	VKD-02	26	WK6-LN	74	WRD-ISC-O	16	XUB-05	116
UVA-200-LED	285	VKD-22	26	WK6-M	74	WRD-LD	16	ZAW-090	93
UVA-400-LED	286	VKD-44	26	WK6-MN	74	WRD-RK	41	ZFK-3007	39
UVAA-170-LED	286	VKS-202	28	WK6-MXN	73	WRD-SKB	107	ZGL-195	38
UVB-150T	284	VR-205	273	WK6-N-SET	73	WRD-SP130	109	ZK-35	41
UVN-200-LED	285	VR-215	273	WK6-S	74	WRD-SS153	109	ZK-45	41
UVN-806	262	VR-305	273	WK6-SET	73	WROBK-300K	11	ZK-0119	48
UW-51C1	44	VR-315	273	WK6-SN	74	WROBK-300QC	11	ZK-0119-P	48
UW-51C1-P	44	VR-405	273	WK7	75	WS-782	35	ZK-0125	48
UW-51C2	44	VR-405AF	272	WK7L	75	WS-782P	35	ZK-0125-P	48
UW-51C2-P	44	VR-415	269	WK8DSM	48	WSA-600-0	229	ZK-0138	48
UW-51C4	44	VR-415	273	WK10HD	67	WSA-620	228	ZK-0138-P	48
UW-51C4-P	44	VR-415AF	272	WK11PP	71	WSH-7050	230	ZKS-110	40
UW-109	42	VR-505	273	WK16LR	72	WSK-31	231	ZKS-150	47
UW-119	42	VR-505AF	272	WK17-4	72	WSL-180	221	ZKS-180	47
UW-125	42	VR-515	269	WK17-6	72	WSP-003K	7	ZMK-110	40
UW-132	42	VR-515	273	WK18Z	72	WSP-004K	8	ZML-395	40
UW-138	42	VR-515AF	272	WK18ZS	72	WSR-100	270	ZMQ-425	38
UW-519	43	VRS-1000	189	WK19L	72	WSR-100-1	271	ZMS-382	40
UW-525	43	W-1414	17	WK19L-S	72	WSR-100-A	270	ZMX-400	38
UW-538	43	WAB-150	92	WK19Z	72	WSR-150-1N	266		
UW-550	46	WAB-909	230	WK19ZS	72	WSR-150-2N	266		
UW-565	46	WAF-1535	92	WK24	69	WSR-150-3	267		
UW-719	44	WAN-3650	93	WK24R-S	70	WSR-150-5	267		
UW-725	44	WAS-700	91	WK24-S	69	WSR-150-6N	266		
UW-738	44	WAS-1630	92	WK24Z	69	WSR-150-A	264		
UW-1000-P	42	WAS-4530	93	WK24ZR-S	70	WSR-150-N	264		
UW-1001-P	42	WAV-899	93	WK24Z-S	69	WSR-150-P	265		
UW-1002-P	42	WAZ-919	94	WK24ZV	70	WSR-150-P	278		
UW-1003-P	42	WDS-025	94	WK24ZVR-S	70	WSR-300-3	267		
UW-1004-P	42	WH-440	233	WK24ZV-S	70	WSR-800	258		
UW-1012	46	WK1	68	WK27L	71	WSR-800-1	262		
UW-1022	46	WK1-S	68	WK27M	71	WSR-800-3	262		
UW-3001	39	WK1-X	68	WK27RM	71	WSR-800-4	263		
UW-3001	39	WK1-ZX	68	WK27S	71	WSR-800-5	263		
UW-3001RK	39	WK2	68	WK27XL	71	WSR-800-6	263		
UW-3007	39	WK2-S	68	WK28L	71	WSR-800-7	260		
UW-3055-K	41	WK3	69	WK28M	71	WSR-800K	258		
UW-5001-P	43	WK3-S	69	WK28RM	71	WSR-800K-BO	260		
UW-5002-P	43	WK4	69	WK28S	71	WSR-800-PH	260		
UW-5004-P	43	WK4R-S	70	WK28XL	71	WSR-800-PHS	260		
UW-5500	47	WK4-S	69	WKB-300	230	WSR-800-SH	259		
UW-5501	47	WK4Z	69	WKB-400	230	WSR-800W	259		
UW-5502	47	WK4ZR-S	70	WKBTR15-BX	67	WSW-800	259		
UW-5503	47	WK4Z-S	69	WKCLS-BX	65	WZA-4022	288		
UW-6991	43	WK4ZVR-S	70	WK-KEY	75	WZK-5829S	243		
UW-6992	43	WK4ZV-S	70	WKSTR-BX	65	WZK-6732S	243		
UW-6994	43	WK5	69	WKTDM-BX	66	WZK-7749-R	242		

## Room for Your Notes

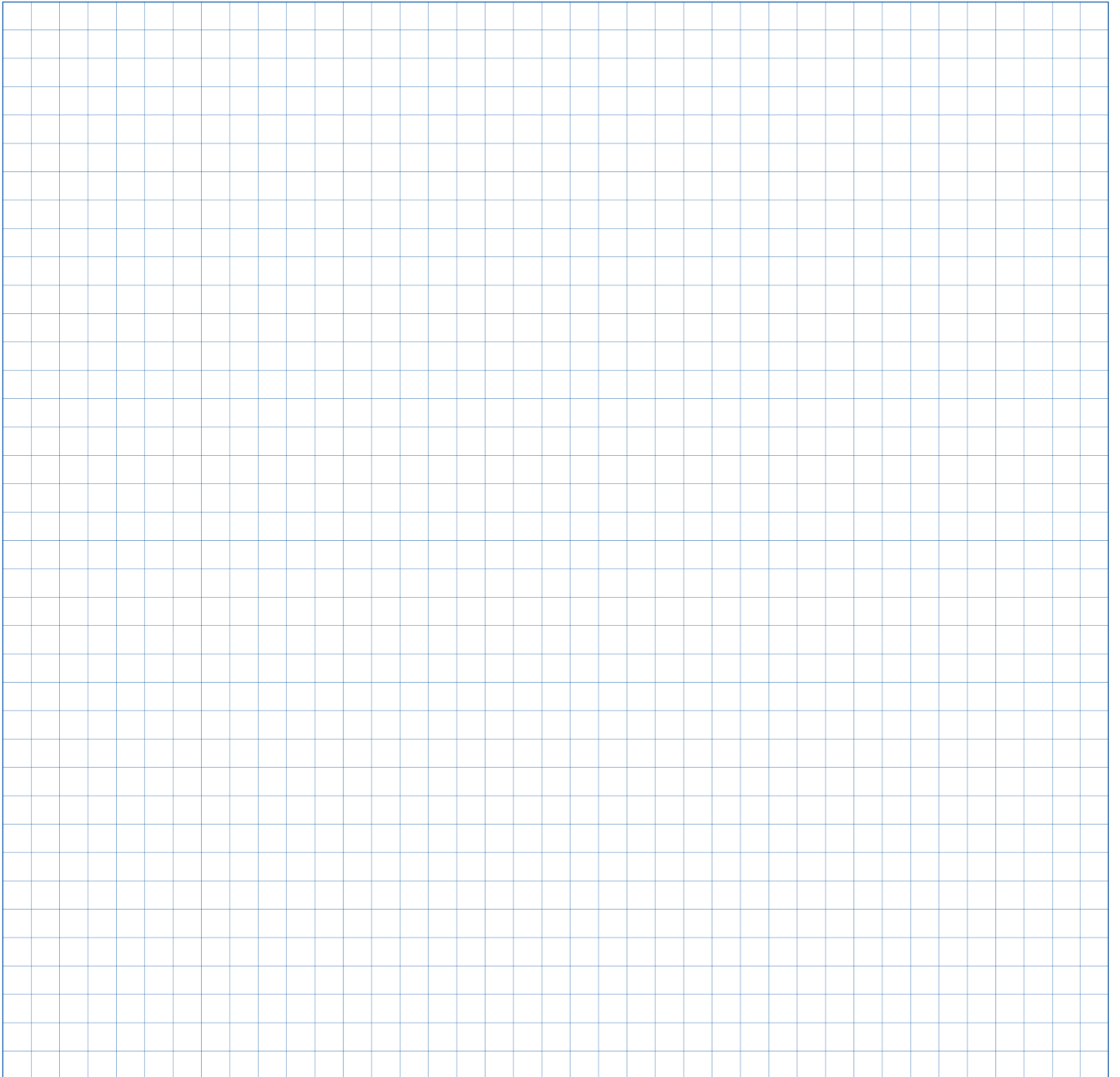

**Room for Your Notes**

A large rectangular area filled with a light blue grid pattern, intended for students to write their notes. The grid consists of small, uniform squares.

## Room for Your Notes

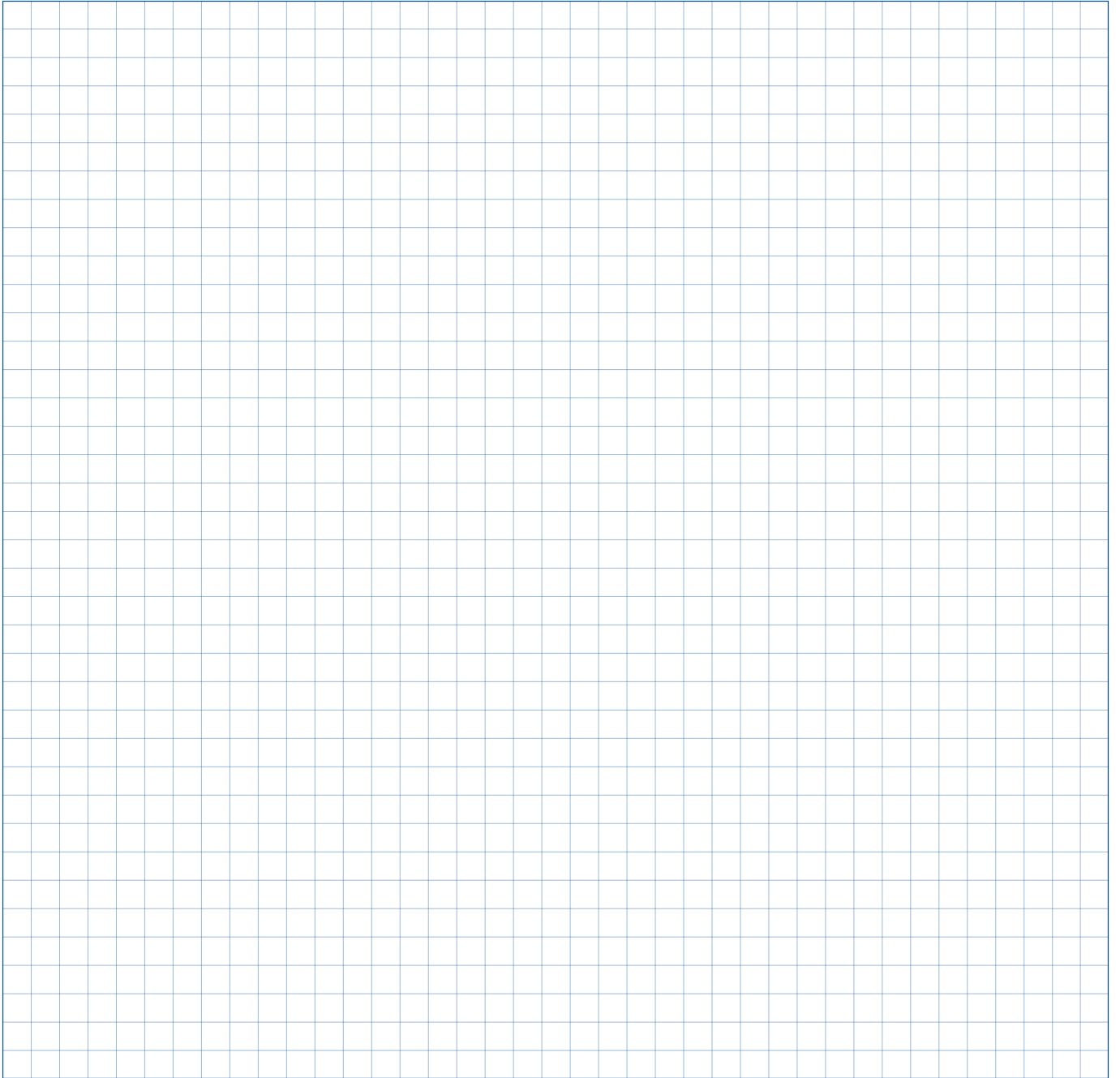

## General Terms And Conditions

### 1. Conclusion of Contract

The following general terms and conditions are subject to all deliveries and services of ProGlass GmbH, hereinafter called ProGlass. Deviations of these terms and conditions on side of the purchaser are only recognised insofar as ProGlass expressly agrees to them in writing. The purchaser is bound to his order for three weeks. In case of unauthorised withdraw, ProGlass can claim damages including lost profit. ProGlass is entitled to decline acceptance of order for featured articles or goods out of stock, within three weeks after order has been placed.

### 2. Prices

All prices are net, excluding VAT (Value Added Tax). Prices are subject to change without prior notice at any time.

### 3. Delivery

FCA (Free Carrier) Weilheim/Teck, Germany, including packing, excluding transportation costs and customs duties. The transportation is at the consignee's risk. Apart from other delivery specifications on part of the purchaser, delivery is carried out by parcel service or, depending on the size of consignment, by forwarding agent.

### 4. Payment

Purchasing price as well as possible additional charges are payable with delivery. All invoices are to be paid to the imprest account named by ProGlass. Cheque payment is only considered as effected on day of encashment. Possible cheque fees are at the expense of the purchaser. We reserve the right to ask for payment in advance or cash on delivery for all new customer accounts.

### 5. Minimum order

For commercial end users in Germany the minimum order value is fixed at 15,00 Euro. Please note that the different export regulations for EU, EFTA and Third countries may result in different minimum order values. To receive further information for your country please contact us.

### 6. Return of goods

Please use our online complaints form ( <https://proglass.de/en/service-area> ) for all returns and repair orders. Any returns have to be notified and authorised in advance. Acceptance of returned items is at our sole discretion. All returns are subject to a general restocking fee of 15% of the net value of goods. Items will not be credited if they are damaged, used or in any other way not saleable.

### 7. Warranty

Any warranty claims must be submitted immediately in written form. It is our sole right under this warranty to repair the defective item or replace it, at our option, without charge. Unless otherwise specified, all sold items are expressly warranted to be free from defects in material and workmanship for 12 months (for commercial purchasers) and 24 month respectively (for private individuals) from the date of delivery. All other warranties are disclaimed.

### 8. Ownership reservation

Title to the goods shall remain with the seller until all outstanding amounts are fully paid. In the case of resale the debt claim to the third party is to be assigned to the seller.

### 9. Data storage

Person related data in connection with the privity of contract will be stored by us.

### 10. Place of performance and jurisdiction

Place of performance and jurisdiction is D-73230 Kirchheim unter Teck (Germany). We reserve the right to sue at the place of the registered office or residence of the buyer.

As of July 2024 (updated version on our website [www.proglass.de](http://www.proglass.de) or upon request)